



## User Manual

Read and understand this manual before using machine.

---

# 10" TABLE SAW



Shown with optional  
Industrial Fence  
and Extension Table



**Model Numbers**  
**35620, 35631**

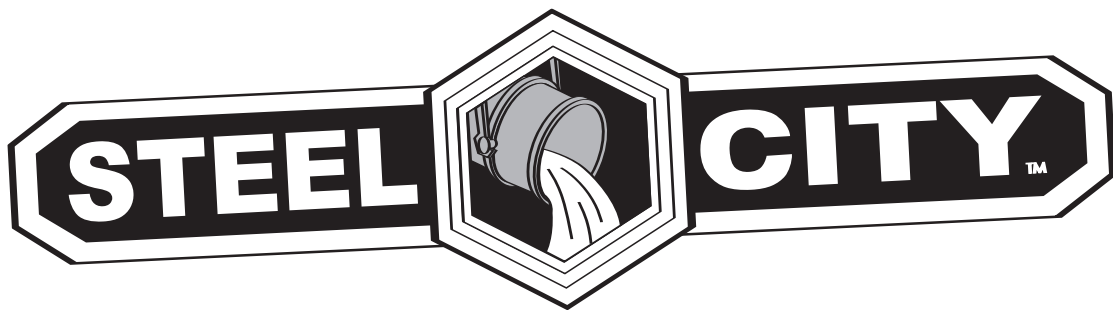

**THANK YOU** for purchasing your new Steel City Table Saw. This table saw has been designed, tested, and inspected with you, the customer, in mind. When properly assembled, used and maintained, your table saw will provide you with years of trouble free service, which is why it is backed by one of the longest machinery warranties in the business.

This table saw is just one of many products in the Steel City's family of woodworking machinery and is proof of our commitment to total customer satisfaction.

At Steel City we continue to strive for excellence each and every day and value the opinion of you, our customer. For comments about your table saw or Steel City Tool Works, please visit our web site at [www.steelcitytoolworks.com](http://www.steelcitytoolworks.com) .

# TABLE OF CONTENTS

## INTRODUCTION

<b>SECTION 1</b>	Warranty .....	4
<b>SECTION 2</b>	Product Specifications .....	7
<b>SECTION 3</b>	Accessories and Attachments .....	7
<b>SECTION 4</b>	Definition of Terms .....	8
<b>SECTION 5</b>	Feature Identification .....	9
<b>SECTION 6</b>	General Safety .....	10
<b>SECTION 7</b>	Product Safety .....	12
<b>SECTION 8</b>	Electrical Requirements .....	14
<b>SECTION 9</b>	Unpacking & Inventory .....	15
<b>SECTION 10</b>	Assembly .....	17
<b>SECTION 11</b>	Adjustments .....	19
<b>SECTION 12</b>	Operations .....	23
<b>SECTION 13</b>	Maintenance .....	27
<b>SECTION 14</b>	Troubleshooting .....	28
<b>SECTION 15</b>	Parts List .....	30-35

## INTRODUCTION

This user manual is intended for use by anyone working with this machine. It should be kept available for immediate reference so that all operations can be performed with maximum efficiency and safety. Do not attempt to perform maintenance or operate this machine until you have read and understand the information contained in this manual.

The drawings, illustrations, photographs, and specifications in this user manual represent your machine at time of print. However, changes may be made to your machine or this manual at any time with no obligation to Steel City Tool Works.

# WARRANTY

## STEEL CITY TOOL WORKS 5 YEAR LIMITED WARRANTY

Steel City Tool Works, LLC (“SCTW”) warrants all “STEEL CITY TOOL WORKS” machinery to be free of defects in workmanship and materials for a period of 5 years from the date of the original retail purchase by the original owner. SCTW will repair or replace, at its expense and at its option, any SCTW machine, machine part, or machine accessory which in normal use has proven to be defective, provided that the customer returns the product, shipping prepaid, to an authorized service center with proof of purchase and provides SCTW with a reasonable opportunity to verify the alleged defect by inspection. This warranty does not apply to defects due directly or indirectly to misuse, abuse, negligence, accidents, or lack of maintenance, or to repairs or alterations made or specifically authorized by anyone other than SCTW. Normal wear components are also excluded under this coverage. Every effort has been made to ensure that all SCTW machinery meets the highest quality and durability standards. We reserve the right to change specifications at any time due to our commitment to continuous improvement of the quality of our products.

EXCEPT AS SET FORTH ABOVE, SCTW MAKES NO EXPRESS OR IMPLIED REPRESENTATIONS OR WARRANTIES WITH RESPECT TO ITS MACHINERY, OR ITS CONDITION, MERCHANTABILITY, OR FITNESS FOR ANY PARTICULAR PURPOSE OR USE. SCTW FURNISHES THE ABOVE WARRANTIES IN LIEU OF ALL OTHER WARRANTIES, EXPRESS OR IMPLIED, INCLUDING THE WARRANTIES OF MERCHANTABILITY AND FITNESS FOR A PARTICULAR PURPOSE, WHICH ARE HEREBY SPECIFICALLY DISCLAIMED.

SCTW SHALL NOT BE LIABLE FOR ANY (A) SPECIAL, INDIRECT, INCIDENTAL, PUNITIVE OR CONSEQUENTIAL DAMAGES, INCLUDING WITHOUT LIMITATION LOSS OF PROFITS, ARISING FROM OR RELATED TO THIS WARRANTY, THE BREACH OF ANY AGREEMENT OR WARRANTY, OR THE OPERATION OR USE OF ITS MACHINERY, INCLUDING WITHOUT LIMITATION DAMAGES ARISING FROM DAMAGE TO FIXTURES, TOOLS, EQUIPMENT, PARTS OR MATERIALS, DIRECT OR INDIRECT LOSS CAUSED BY ANY OTHER PARTY, LOSS OF REVENUE OR PROFITS, FINANCING OR INTEREST CHARGES, AND CLAIMS BY ANY THIRD PERSON, WHETHER OR NOT NOTICE OF SUCH POSSIBLE DAMAGES HAS BEEN GIVEN TO SCTW; (B) DAMAGES OF ANY KIND FOR ANY DELAY BY OR FAILURE OF SCTW TO PERFORM ITS OBLIGATIONS UNDER THIS AGREEMENT; OR (C) CLAIMS MADE A SUBJECT OF A LEGAL PROCEEDING AGAINST SCTW MORE THAN ONE (1) YEAR AFTER SUCH CAUSE OF ACTION FIRST AROSE.

The validity, construction and performance of this Warranty and any sale of machinery by SCTW shall be governed by the laws of the Commonwealth of Pennsylvania, without regard to conflicts of laws provisions of any jurisdiction. Any action related in any way to any alleged or actual offer, acceptance or sale by SCTW, or any claim related to the performance of any agreement including without limitation this Warranty, shall take place in the federal or state courts in Allegheny County, Pennsylvania.

**STEEL CITY TOOL WORKS**

# WARRANTY CARD

Name \_\_\_\_\_  
 Street \_\_\_\_\_  
 Apt. No. \_\_\_\_\_  
 City \_\_\_\_\_ State \_\_\_\_\_ Zip \_\_\_\_\_  
 Phone Number \_\_\_\_\_  
 E-Mail \_\_\_\_\_

Product Description: \_\_\_\_\_  
 Model No.: \_\_\_\_\_  
 Serial No. \_\_\_\_\_

***The following information is given on a voluntary basis and is strictly confidential.***

1. Where did you purchase your STEEL CITY machine?  
 Store: \_\_\_\_\_  
 City: \_\_\_\_\_

2. How did you first learn of Steel City Tool Works?  
 Advertisement       Mail Order Catalog  
 Web Site             Friend  
 Local Store         Other \_\_\_\_\_

3. Which of the following magazines do you subscribe to?  
 American Woodworker       American How-To  
 Cabinetmaker                 Family Handyman  
 Fine Homebuilding          Fine Woodworking  
 Journal of Light Construction    Old House Journal  
 Popular Mechanics          Popular Science  
 Popular Woodworking        Today's Homeowner  
 WOOD                          Woodcraft  
 WOODEN Boat                Woodshop News  
 Woodsmith                   Woodwork  
 Woodworker                  Woodworker's Journal  
 Workbench                 Other \_\_\_\_\_

4. Which of the following woodworking / remodeling shows do you watch?  
 Backyard America       The American Woodworker  
 Home Time                 The New Yankee Workshop  
 This Old House          Woodwright's Shop  
 Other \_\_\_\_\_

5. What is your annual household income?  
 \$20,000 to \$29,999       \$30,000 to \$39,999  
 \$40,000 to \$49,999       \$50,000 to \$59,999  
 \$60,000 to \$69,999       70,000 to \$79,999  
 \$80,000 to \$89,999       \$90,000 +

6. What is your age group?  
 20 to 29 years             30 to 39 years  
 40 to 49 years             50 to 59 years  
 60 to 69 years             70 + years

7. How long have you been a woodworker?  
 0 to 2 years                 2 to 8 years  
 8 to 20 years               over 20 years

8. How would you rank your woodworking skills?  
 Simple                       Intermediate  
 Advance                     Master Craftsman

9. How many Steel City machines do you own? \_\_\_\_\_

10. What stationary woodworking tools do you own?  
*Check all that apply.*  
 Air Compressor             Band Saw  
 Drill Press                   Drum Sander  
 Dust Collection             Horizontal Boring Machine  
 Jointer                       Lathe  
 Mortiser                     Panel Saw  
 Planer                         Power Feeder  
 Radial Arm Saw             Shaper  
 Spindle Sander             Table Saw  
 Vacuum Veneer Press     Wide Belt Sander  
 Other \_\_\_\_\_

11. Which benchtop tools do you own? *Check all that apply.*  
 Belt Sander                 Belt / Disc Sander  
 Drill Press                  Band Saw  
 Grinder                     Mini Jointer  
 Mini Lathe                  Scroll Saw  
 Spindle / Belt Sander    Other \_\_\_\_\_

12. Which portable / hand held power tools do you own?  
*Check all that apply.*  
 Belt Sander                 Biscuit Jointer  
 Dust Collector             Circular Saw  
 Detail Sander              Drill / Driver  
 Miter Saw                  Orbital Sander  
 Palm Sander                Portable Thickness Planer  
 Saber Saw                  Reciprocating Saw  
 Router                      Other \_\_\_\_\_

13. What machines / accessories would you like to see added to the STEEL CITY line?  
 \_\_\_\_\_  
 \_\_\_\_\_

14. What new accessories would you like to see added?  
 \_\_\_\_\_  
 \_\_\_\_\_

15. Do you think your purchase represents good value?  
 Yes                         No

16. Would you recommend STEEL CITY products to a friend?  
 Yes                         No

17. Comments:  
 \_\_\_\_\_  
 \_\_\_\_\_  
 \_\_\_\_\_  
 \_\_\_\_\_

CUT HERE

FOLD ON DOTTED LINE

---

PLACE  
STAMP  
HERE

**Steel City Tool Works**  
**P.O. Box 10529**  
**Murfreesboro, TN 37129**

---

FOLD ON DOTTED LINE

# PRODUCT SPECIFICATIONS

Blade Tilt	Right
Blade Diameter	10"
Arbor Diameter	5/8"
Maximum, Depth of Cut	3-1/8"
Maximum Thickness at 45 degrees	2-1/8"
Table in front of Saw Blade at Maximum cut	12"
Maximum Width of Dado	13/16"
Maximum Diameter of Dado	8"
Dust Port Diameter	4"
Table Height	34-1/2"
Table size (with extensions)	27" x 40"
Table size (without extensions)	27" x 20"
Blade Speed	4150 RPM

## Product Dimensions

Footprint	20-1/2" x 20-1/2"
Length	40-1/4"
Width	27"
Height	34"
Net Weight	385 Lbs.

## Shipping Dimensions

Carton Type	Wooden Crate on skid
Length	34-1/2"
Width	29"
Height	40-1/2"
Gross Weight	414 Lbs.

## Motor

Type	T.E.F.C. Induction
Horsepower	3HP
Amps	12
Voltage	230V
Phase	Single
Hertz	60
RPM	3450

# ACCESSORIES AND ATTACHMENTS

There are a variety of accessories available for your Steel City Product. For more information on any accessories associated with this and other machines, please contact your nearest Steel City distributor, or visit our website at: [www.steelcitytoolworks.com](http://www.steelcitytoolworks.com).

# DEFINITION OF TERMS

**Anti-Kickback Fingers** – A safety device attached to the blade guard and splitter assembly designed to minimize the chance of a workpiece being thrown back during a cutting operation.

**Arbor** – The shaft on which the blade or accessory cutting-tool is mounted.

**Bevel Cut** – The operation of making any cut with the blade set at an angle other than 90 degrees.

**Compound Cut** – The operation of making both a bevel and a miter cut at one time.

**Crosscut** – The operation of making a cut across the grain or width of a workpiece.

**Dado** – A non-through cut that produces a square notch. A dado is typically from 1/8-in. to 13/16-in. wide. A dado requires a special set of blades, not included with this table saw and a special insert, which is included.

**Featherboard** – An accessory device that can be made or purchased to help guide or hold down a workpiece during cutting operations.

**Freehand** – A very dangerous operation of making a cut without using the fence or miter gauge in a cutting operation. Freehand cuts must never be performed on a Table Saw.

**Gum, Pitch or Resin** – A sticky, sap based residue that comes from wood products.

**Heeling** – The misalignment of the blade to the miter slots; when the blade is not parallel to the miter slots.

**Kerf** – The material removed from the workpiece by the blade during any cutting operation.

**Kickback** – When the workpiece is thrown back toward the operator at a high rate of speed during a cutting operation.

**Miter Cut** – The operation of making a cut using the miter gauge at any angle other than zero degrees.

**Push Stick** – An accessory device that can be made or purchased to help push the workpiece through the blade. A push stick is used to keep the operator's hands away from the blade when ripping a narrow workpiece.

**Rabbet** – A square notch in the edge of the workpiece.

**Rip Cut** – The operation of making a cut with the grain or down the length of the workpiece.

**Saw Blade Path** – The area that is directly in line with the blade, including area over, under, behind and in front of it.

**Set of the Saw Blade** – The distance that the tips of the saw blade are angled outwards from the thickness of the blade. The set of the saw blade teeth allows for the blade body to pass safely through all cuts.

**Table/Work Area** – The total surface of the top of the table saw on which the workpiece rests while set-up or cutting operations are being performed.



# FEATURE IDENTIFICATION

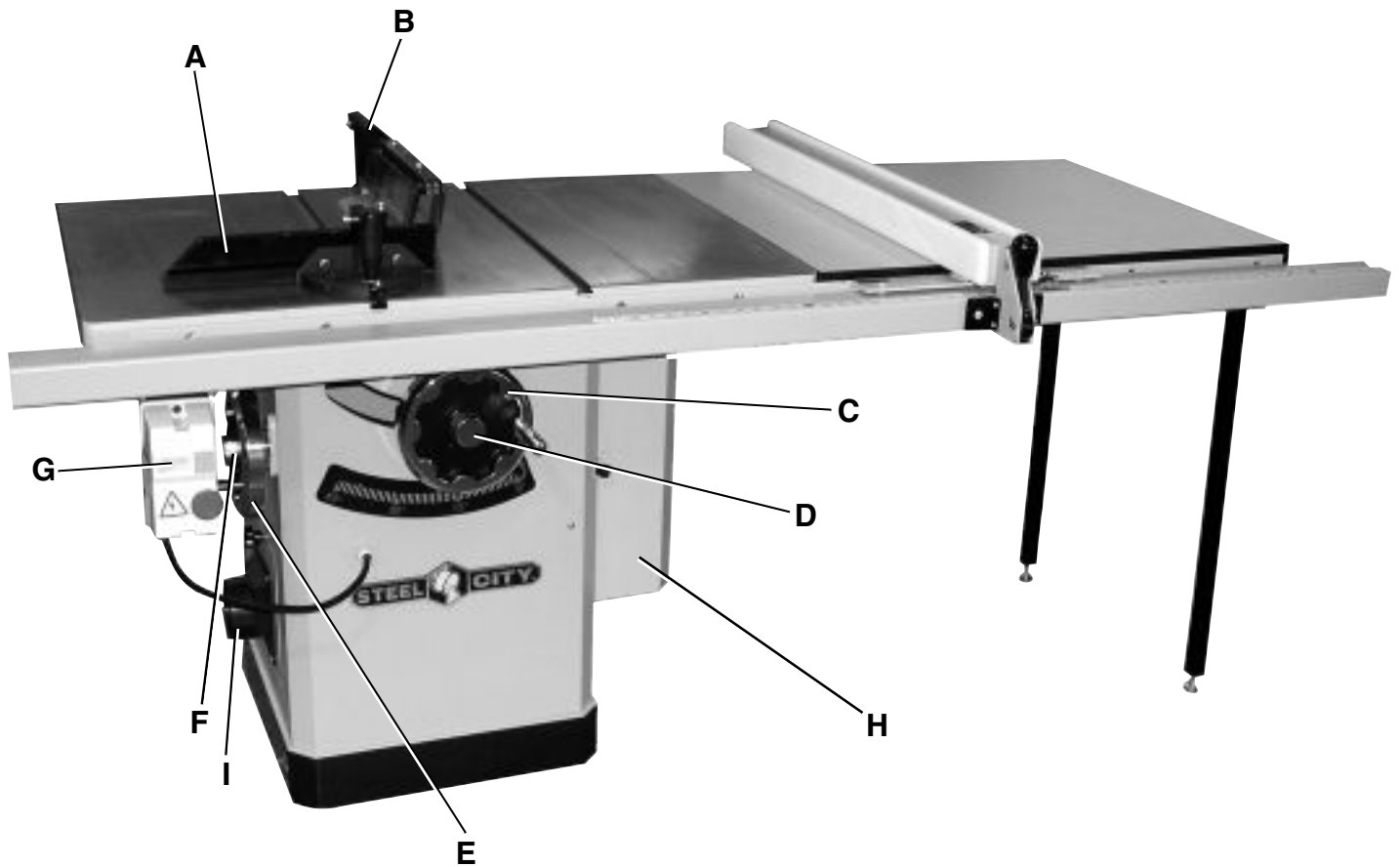

- A. Miter Gauge Assembly
- B. Blade Guard Assembly
- C. Blade Height Adjustment Handwheel
- D. Blade Height Lock Knob
- E. Bevel Adjustment Handwheel
- F. Bevel Lock Knob
- G. Switch
- H. Motor Cover
- I. Dust Port

(shown with optional industrial fence and extension table)

# GENERAL SAFETY

## **⚠ WARNING**

**TO AVOID** serious injury and damage to the machine, read and follow all Safety and Operating Instructions before assembling and operating this machine.

This manual is not totally comprehensive. It does not and can not convey every possible safety and operational problem which may arise while using this machine. The manual will cover many of the basic and specific safety procedures needed in an industrial environment.

All federal and state laws and any regulations having jurisdiction covering the safety requirements for use of this machine take precedence over the statements in this manual. Users of this machine must adhere to all such regulations.

Below is a list of symbols that are used to attract your attention to possible dangerous conditions.



This is the international safety alert symbol. It is used to alert you to potential personal injury hazards. Obey all safety messages that follow this symbol to avoid possible injury or death.

## **⚠ DANGER**

Indicates an imminently hazardous situation which, if not avoided, **WILL** result in death or serious injury.

## **⚠ WARNING**

Indicates a potentially hazardous situation which, if not avoided, **COULD** result in death or serious injury.

## **⚠ CAUTION**

Indicates a potentially hazardous situation, if not avoided, **MAY** result in minor or moderate injury. It may also be used to alert against unsafe practices.

## **CAUTION**

**CAUTION** used without the safety alert symbol indicates a potentially hazardous situation which, if not avoided, may result in property damage.

## **NOTICE**

This symbol is used to alert the user to useful information about proper operation of the machine.

## **⚠ WARNING**

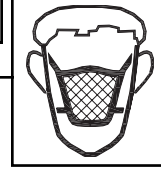

Exposure to the dust created by power sanding, sawing, grinding, drilling and other construction activities may cause serious and permanent respiratory or other injury, including silicosis (a serious lung disease), cancer, and death. Avoid breathing the dust, and avoid prolonged contact with dust. The dust may contain chemicals known to the State of California to cause cancer, birth defects or other reproductive harm.

Some examples of these chemicals are:

- Lead from lead-based paints.
- Crystalline silica from bricks, cement and other masonry products.
- Arsenic and chromium from chemically-treated lumber.

Always operate tool in well ventilated area and provide for proper dust removal. Use a dust collection system along with an air filtration system whenever possible. Always use properly fitting NIOSH/OSHA approved respiratory protection appropriate for the dust exposure, and wash exposed areas with soap and water.

1. To avoid serious injury and damage to the machine, read the entire User Manual before assembly and operation of this machine.

## **⚠ WARNING**

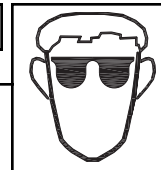

2. **ALWAYS** wear eye protection. Any machine can throw debris into the eyes during operations, which could cause severe and permanent eye damage. Everyday eyeglasses are **NOT** safety glasses. **ALWAYS** wear Safety Goggles (that comply with ANSI standard Z87.1) when operating power tools.

**▲ WARNING**

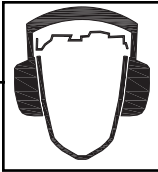

3. **ALWAYS** wear hearing protection. Plain cotton is not an acceptable protective device. Hearing equipment should comply with ANSI S3.19 Standards.

**▲ WARNING**

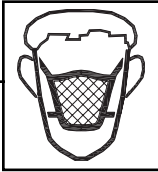

4. **ALWAYS** wear a NIOSH/OSHA approved dust mask to prevent inhaling dangerous dust or airborne particles.

5. **ALWAYS** keep the work area clean, well lit, and organized. **DO NOT** work in an area that has slippery floor surfaces from debris, grease, and wax.
6. **ALWAYS** unplug the machine from the electrical receptacle before making adjustments, changing parts or performing any maintenance.
7. **AVOID ACCIDENTAL STARTING.** Make sure that the power switch is in the "OFF" position before plugging in the power cord to the electrical receptacle.

**▲ WARNING**



8. **AVOID** a dangerous working environment. **DO NOT** use electrical tools in a damp environment or expose them to rain or moisture.

**▲ WARNING**

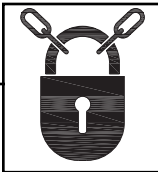

9. **CHILDPROOF THE WORKSHOP AREA** by removing switch keys, unplugging tools from the electrical receptacles, and using padlocks.

10. **DO NOT** use electrical tools in the presence of flammable liquids or gasses.

11. **DO NOT FORCE** the machine to perform an operation for which it was not designed. It will do a safer and higher quality job by only performing operations for which the machine was intended.
12. **DO NOT** stand on a machine. Serious injury could result if it tips over or you accidentally contact any moving part.
13. **DO NOT** store anything above or near the machine.
14. **DO NOT** operate any machine or tool if under the influence of drugs, alcohol, or medication.
15. **EACH AND EVERY** time, check for damaged parts prior to using any machine. Carefully check all guards to see that they operate properly, are not damaged, and perform their intended functions. Check for alignment, binding or breakage of all moving parts. Any guard or other part that is damaged should be immediately repaired or replaced.
16. Ground all machines. If any machine is supplied with a 3-prong plug, it must be plugged into a 3-contact electrical receptacle. The third prong is used to ground the tool and provide protection against accidental electric shock. **DO NOT** remove the third prong.
17. Keep visitors and children away from any machine. **DO NOT** permit people to be in the immediate work area, especially when the machine is operating.
18. **KEEP** protective guards in place and in working order.
19. **MAINTAIN** your balance. **DO NOT** extend yourself over the tool. Wear oil resistant rubber soled shoes. Keep floor clear of debris, grease, and wax.
20. **MAINTAIN** all machines with care. **ALWAYS KEEP** machine clean and in good working order. **KEEP** all blades and tool bits sharp.
21. **NEVER** leave a machine running, unattended. Turn the power switch to the OFF position. **DO NOT** leave the machine until it has come to a complete stop.
22. **REMOVE ALL MAINTENANCE TOOLS** from the immediate area prior to turning the machine ON.
23. **SECURE** all work. When it is possible, use clamps or jigs to secure the workpiece. This is safer than attempting to hold the workpiece with your hands.
24. **STAY ALERT**, watch what you are doing, and use common sense when operating any machine. **DO NOT** operate any machine tool while tired or under the influence of drugs, alcohol, or medication. A moment of inattention while operating power tools may result in serious personal injury.

25. **USE ONLY** recommended accessories. Use of incorrect or improper accessories could cause serious injury to the operator and cause damage to the machine. If in doubt, **DO NOT** use it.
26. **THE USE** of extension cords is not recommended for 230V equipment. It is better to arrange the placement of your equipment and the installed wiring to eliminate the need for an extension cord. If an extension cord is necessary, refer to the chart in the Grounding Instructions section to determine the minimum gauge for the extension cord. The extension cord must also contain a ground wire and plug pin.
27. Wear proper clothing, **DO NOT** wear loose clothing, gloves, neckties, or jewelry. These items can get caught in the machine during operations and pull the operator into the moving parts. Users must wear a protective cover on their hair, if the hair is long, to prevent it from contacting any moving parts.
28. **SAVE** these instructions and refer to them frequently and use them to instruct other users.
29. Information regarding the safe and proper operation of this tool is also available from the following sources:
  - Power Tool Institute  
1300 Summer Avenue  
Cleveland, OH 44115-2851  
www.powertoolinstitute.org
  - National Safety Council  
1121 Spring Lake Drive  
Itasca, IL 60143-3201
  - American National Standards Institute  
25 West 43rd St, 4th Floor  
New York, NY. 10036  
ANSI 01.1 Safety Requirements  
For Woodworking Machines  
WWW.ANSI.ORG
  - U.S. Department of Labor Regulations  
OSHA 1910.213 Regulations  
WWW.OSHA.GOV

## PRODUCT SAFETY

1. Serious personal injury may occur if normal safety precautions are overlooked or ignored. Accidents are frequently caused by lack of familiarity or failure to pay attention. Obtain advice from supervisor, instructor, or another qualified individual who is familiar with this machine and its operations.
2. Every work area is different. Always consider safety first, as it applies to your work area. Use this machine with respect and caution. Failure to do so could result in serious personal injury and damage to the machine.
3. Prevent electrical shock. Follow all electrical and safety codes, including the National Electrical Code (NEC) and the Occupational Safety and Health Regulations (OSHA). All electrical connections and wiring should be made by qualified personnel only.
4. **TO REDUCE** the risk of electrical shock. **DO NOT** use this machine outdoors. **DO NOT** expose to rain or moisture. Store indoors in a dry area.
5. **STOP** using this machine, if at any time you experience difficulties in performing any operation. Contact your supervisor, instructor or machine service center immediately.
6. Safety decals are on this machine to warn and direct you to how to protect yourself or visitors from personal injury. These decals **MUST** be maintained so that they are legible. **REPLACE** decals that are not legible.
7. **DO NOT** leave the unit plugged into the electrical outlet. Unplug the unit from the outlet when not in use and before servicing, performing maintenance tasks, or cleaning.
8. **ALWAYS** turn the power switch "OFF" before unplugging the table saw.

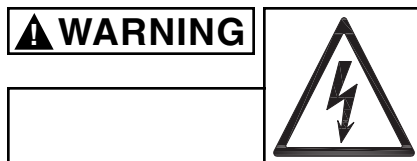

- ▲ WARNING**
4. **TO REDUCE** the risk of electrical shock. **DO NOT** use this machine outdoors. **DO NOT** expose to rain or moisture. Store indoors in a dry area.



- ▲ WARNING**
9. **DO NOT** handle the plug or table saw with wet hands.

10. **USE** accessories only recommended by Steel City.
11. **DO NOT** pull the table saw by the power cord. **NEVER** allow the power cord to come in contact with sharp edges, hot surfaces, oil or grease.
12. **DO NOT** unplug the table saw by pulling on the power cord. **ALWAYS** grasp the plug, not the cord.
13. **REPLACE** a damaged cord immediately. **DO NOT** use a damaged cord or plug. **DO NOT** use if the table saw is not operating properly, or has been damaged, left outdoors or has been in contact with water.

14. **DO NOT** use the table saw as a toy. **DO NOT** use near or around children.
15. **ENSURE** that the machine sits firmly on the floor before using. If the machine wobbles or is unstable, correct the problem by using shims or blocks prior to operation.
16. **KEEP** saw blade sharp and clean. Failure to do so greatly increases friction, decreases cut quality, and increases the possibility of a kickback
17. **MAKE CERTAIN** the saw blade is parallel with the miter slots and with the rip fence. A blade that is not aligned parallel can cause the workpiece to be pinched between the blade and the fence causing burning or kickbacks.
18. **ALWAYS** use blade guard on all through cuts. This will help prevent the cut from closing on the back of the saw blade. The blade guard also has anti-kickback fingers which minimize the chance of a workpiece being thrown back during a cutting operation.
19. **ALWAYS** push the workpiece past the blade. **DO NOT** release a workpiece until it is past the blade and removed from the saw.
20. **DO NOT** execute a cut when you do not have complete control of the situation
21. **DO NOT** cut a workpiece that is too large for you to safely handle. Use an outfeed table or workstand to properly support the piece.
22. **DO NOT** use the rip fence as a guide when cross-cutting
23. **BE MINDFUL** of flaws in the wood. Cutting a warped or twisted board along the rip fence can get pinched between the fence and the blade, causing a kickback
24. **ALWAYS** remove cut off pieces and scraps from the table before starting the saw
25. **NEVER** start the machine with the workpiece against the blade
26. **NEVER** perform freehand operations. Use either the fence or miter gauge to position and guide the workpiece through the blade.
27. **ALWAYS** use a pushstick for ripping narrow workpieces
28. **NEVER** have any part of your body in line with the path of the saw blade. If a kickback occurs with you directly in front of the blade, a serious injury can occur.
29. **NEVER** attempt to free a stalled blade without first turning the machine off and disconnecting the saw from the power source.
30. **DO NOT** reach over or behind a rotating saw blade.

## ELECTRICAL REQUIREMENTS

### **WARNING**

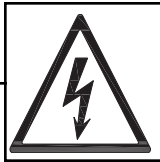

To reduce the risk of electric shock, follow all electrical and safety codes, including the National Electric Code (NEC) and the Occupational Safety and Health Regulations (OSHA). All electrical connections and wiring should be made by qualified personnel only.

The switch provided with your saw is a magnetic switch designed for 230 volt single phase usage only. The switch has a plug that is designed to plug into a 230 volt outlet. There are many different configurations for 230 volt outlets, so it is conceivable that the configuration of the plug may not match the configuration of your existing outlet. If this is the case, you will have to replace the plug with a UL/CSA approved plug that matches the configuration of your 230V outlet.

# GROUNDING INSTRUCTIONS

## ⚠ WARNING



This machine **MUST BE GROUNDED** while in use to protect the operator from electric shock.

In the event of a malfunction or breakdown, **GROUNDING** provides the path of least resistance for electric current and reduces the risk of electric shock. The plug **MUST** be plugged into a matching electrical receptacle that is properly installed and grounded in accordance with **ALL** local codes and ordinances.

If a plug is provided with your machine **DO NOT** modify the plug. If it will not fit your electrical receptacle, have a qualified electrician install the proper connections to meet all electrical codes local and state. All connections must also adhere to all of OSHA mandates.

**IMPROPER ELECTRICAL CONNECTION** of the equipment-grounding conductor can result in risk of electric shock. The conductor with the green insulation (with or without yellow stripes) is the equipment-grounding conductor. **DO NOT** connect the equipment-grounding conductor to a live terminal.

Check with a qualified electrician or service personnel if you do not completely understand the grounding instructions, or if you are not sure the tool is properly grounded.

## PLUGS/RECEPTACLES

## ⚠ WARNING



- Electrocution or fire could result if this machine is not grounded properly or if the electrical configuration does not comply with local and state electrical codes.
- **MAKE CERTAIN** the machine is disconnected from power source before starting any electrical work.
- **MAKE SURE** the circuit breaker does not exceed the rating of the plug and receptacle.

The motor supplied with your machine is a 230 volt, 60 hertz, single phase motor. Never connect the green or ground wire to a live terminal.

A machine with a 230 volt plug should only be connected to an outlet having the same configuration as the plug.

## EXTENSION CORDS

## ⚠ WARNING

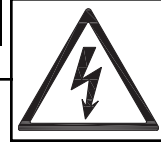

To reduce the risk of fire or electrical shock, use the proper gauge of extension cord. When using an extension cord, be sure to use one heavy enough to carry the current your machine will draw.

The smaller the gauge-number, the larger the diameter of the extension cord is. If in doubt of the proper size of an extension cord, use a shorter and thicker cord. An undersized cord will cause a drop in line voltage resulting in a loss of power and overheating.

## ⚠ CAUTION

**USE ONLY** a 3-wire extension cord that has a 3-prong grounding plug and a 3-pole receptacle that accepts the machine's plug.

If you are using an extension cord outdoors, be sure it is marked with the suffix "W-A" ("W" in Canada) to indicate that it is acceptable for outdoor use.

Make certain the extension cord is properly sized, and in good electrical condition. Always replace a worn or damaged extension cord immediately or have it repaired by a qualified person before using it.

Protect your extension cords from sharp objects, excessive heat, and damp or wet areas.

### MINIMUM RECOMMENDED GAUGE FOR EXTENSION CORDS (AWG)

230 VOLT OPERATION ONLY			
	25' LONG	50' LONG	100' LONG
0 to 6 Amps	16 AWG	16 AWG	14 AWG
6 to 8 Amps	16 AWG	16 AWG	12 AWG
8 to 12 Amps	14 AWG	14 AWG	10 AWG
12 to 15 Amps	12 AWG	12 AWG	10 AWG
15 to 20 Amps	10 AWG	10 AWG	Not recommended

# UNPACKING & INVENTORY

## ⚠ WARNING



- The machine is heavy, two people are required to unpack and lift.
- Use a safety strap to avoid tip over when lifting machine.

Check shipping carton and machine for damage before unpacking. Carefully remove packaging materials, parts and machine from shipping carton. Always check for and remove protective shipping materials around motors and moving parts. Lay out all parts on a clean work surface.

Remove any protective materials and coatings from all of the parts and the table saw. The protective coatings contact Steel City at 1-877-SC4-TOOL.

can be removed by spraying WD-40 on them and wiping it off with a soft cloth. This may need redone several times before all of the protective coatings are removed completely.

After cleaning, apply a good quality paste wax to any unpainted surfaces. Make sure to buff out the wax before assembly.

Compare the items to inventory figures; verify that all items are accounted for before discarding the shipping box.

## ⚠ WARNING

If any parts are missing, do not attempt to plug in the power cord and turn "ON" the machine. The machine should only be turned "ON" after all the parts have been obtained and installed correctly. For missing parts, contact Steel City at 1-877-SC4-TOOL.

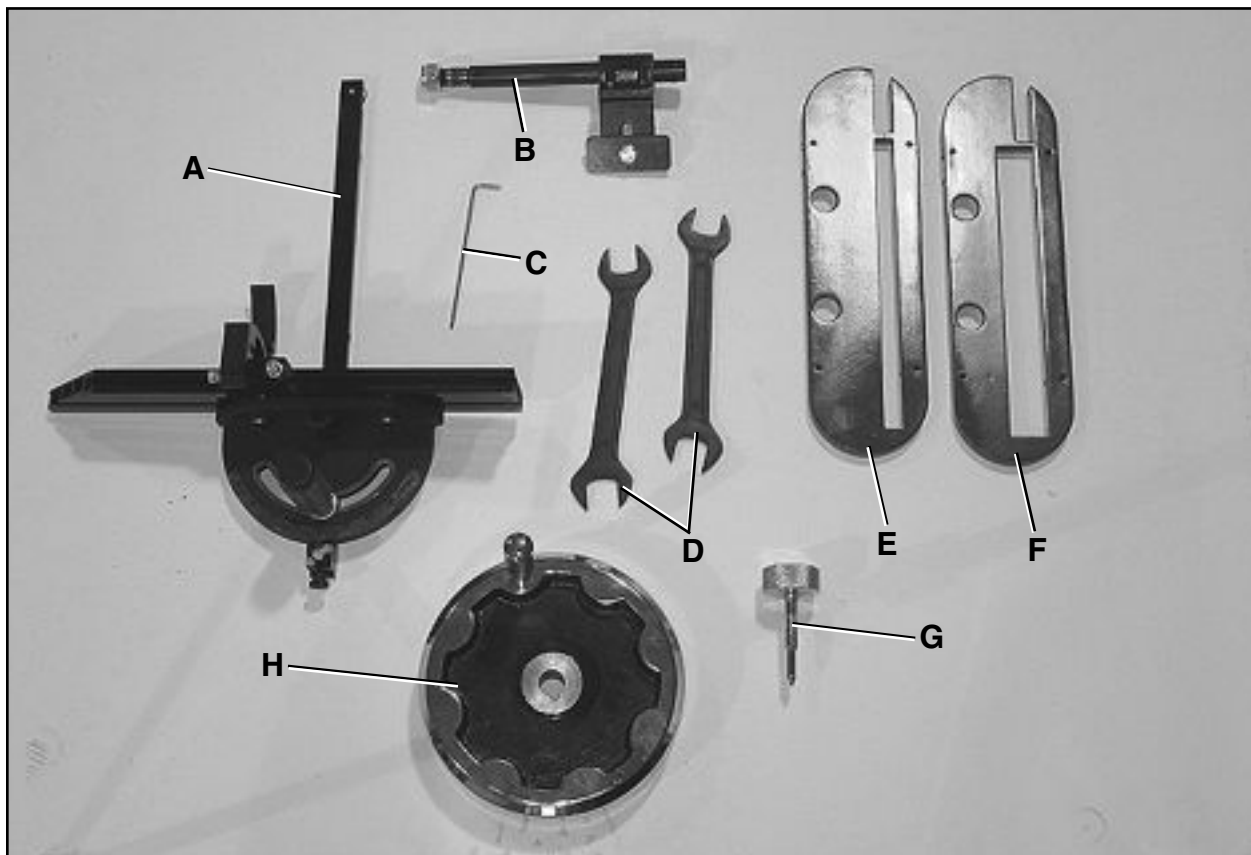

- A. Miter Gauge Assembly
- B. Blade Guard Shaft
- C. Hex Wrench
- D. Blade Wrenches (2)

- E. Standard Insert
- F. Dado Insert
- G. Handwheel Lock Knob
- H. Handwheel

- I. Blade Guard Assembly
- J. Left and Right Cast Iron Wings

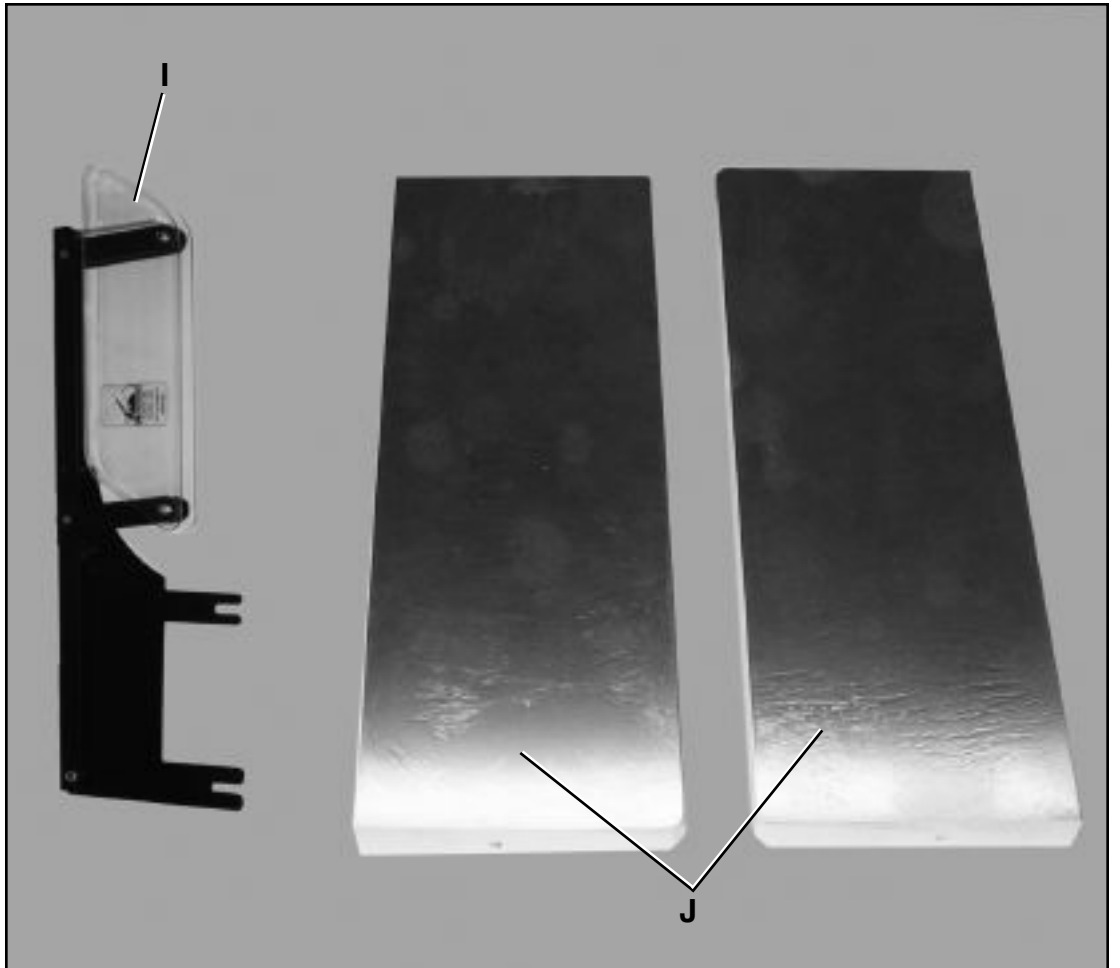

- K. Motor Cover

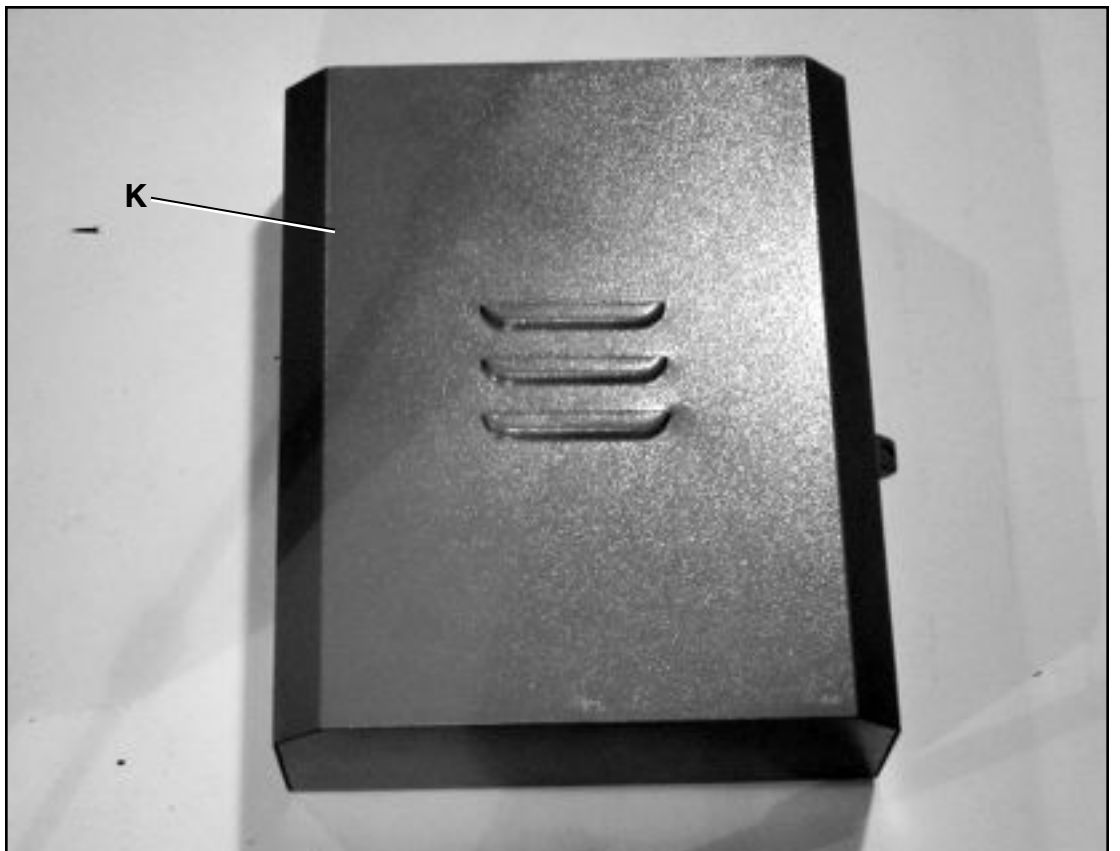



# ASSEMBLY

## **⚠ WARNING**

**MAKE CERTAIN THAT THE SAW IS DISCONNECTED FROM THE POWER SOURCE.**

## INSTALLATION AND LEVELING

Final location for the saw must be level, dry, well lighted, and have enough room to allow movement around the saw with long pieces of wood stock.

Level the saw front to back and side to side, using a carpenter's level placed on the table. Use shims under the corners, if necessary, but make sure the saw is stable before being placed into service.

## MOTOR BRACE DISASSEMBLY

The red motor brace is installed for shipping purposes only. Remove this brace before assembling the saw. **SEE FIG (A).**

**Fig. A**



## MOTOR COVER ASSEMBLY

1. Install motor cover (A) by aligning pins (B) on the cover with brackets on cabinet. **SEE FIG. 1.**
2. Fasten cover with the latch.

**Fig. 1**

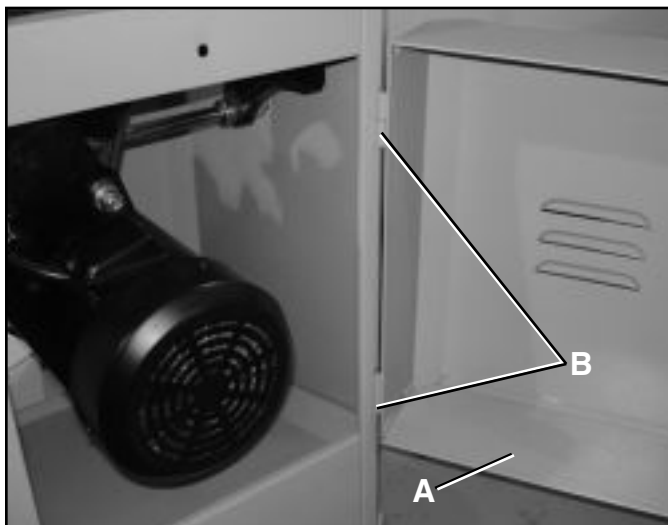

## EXTENSION WING ASSEMBLY

**NOTICE:** There is a specific Left wing and Right wing. When attaching the wings to the saw, **MAKE CERTAIN** that the beveled edges of the wings face towards the front of the saw.

1. Attach extension wing to the table with three hex head bolts, three lock washers, and three flat washers. Snug but do not tighten.
2. Slide the beveled end of the extension wing towards the front edge of the saw table until the beveled edges are flush.
3. Using a straight edge (A), align the extension wings to the saw table and tighten the hex head bolts. **SEE FIG. 2.**

**Fig. 2**

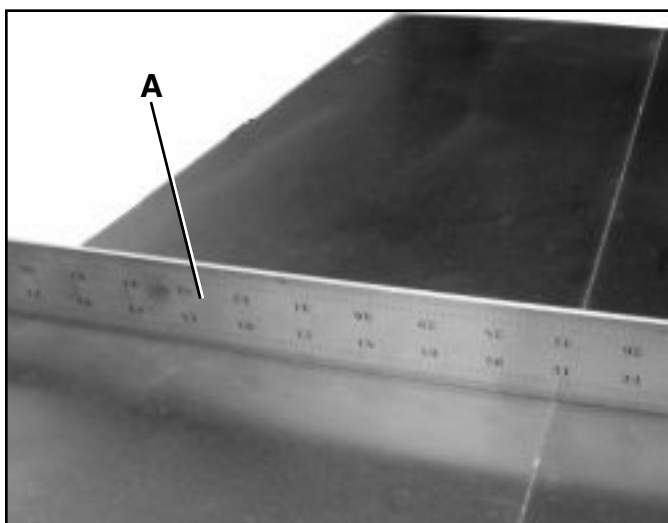

4. Repeat Steps 1-3 for the other wing.

## HANDWHEEL ASSEMBLY

Fig. 3

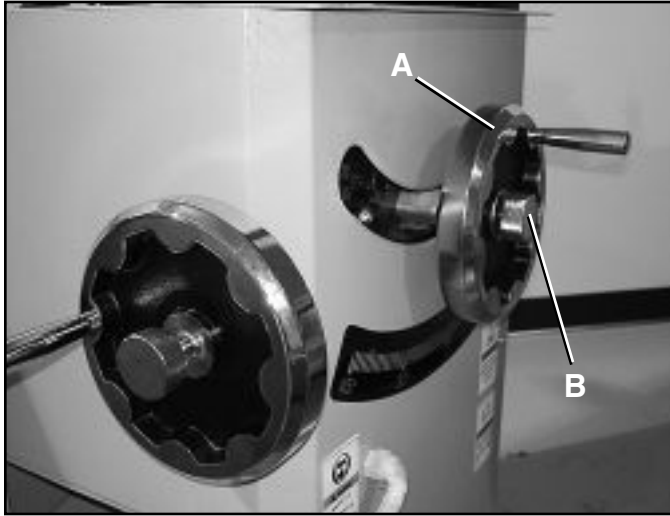

1. Line up the key on the shaft with the keyway in the handwheel (A), and slide the handwheel onto the shaft. **SEE FIG. 3.**
2. Tighten the set screw on the handwheel hub securely to hold in place.
3. Install center lock knob (B) by inserting into center hole in the shaft and threading in a clockwise direction.

## BLADE GUARD ASSEMBLY

### **⚠ WARNING**

**MAKE CERTAIN THAT THE SAW IS DISCONNECTED FROM THE POWER SOURCE.**

1. Install the blade guard shaft into the hole in the casting in the rear of the cabinet.
2. Thread the Nylock nut onto the blade guard shaft. Using a 24mm wrench, tighten the nut on the shaft.

**NOTE:** If needed, you can place a screwdriver through the hole in the end of the blade guard shaft, and turn it clockwise while holding the nut stationary with the wrench.

3. Place the upper and lower bracket assembly in the upright position and snug the two set screws just enough to hold in place.
4. Insert front tab of the blade guard assembly through insert opening in the table. Loosen the hex head screw (A) already installed at the factory and insert the front tab of the blade guard. The tab is held in place between the flat washer and bracket. Finger-tighten only at this time. **SEE FIG. 5.**
5. Attach the rear tab of the blade guard assembly to the upper blade guard bracket with one hex head bolt (B). Finger-tighten only at this time.

Fig. 5

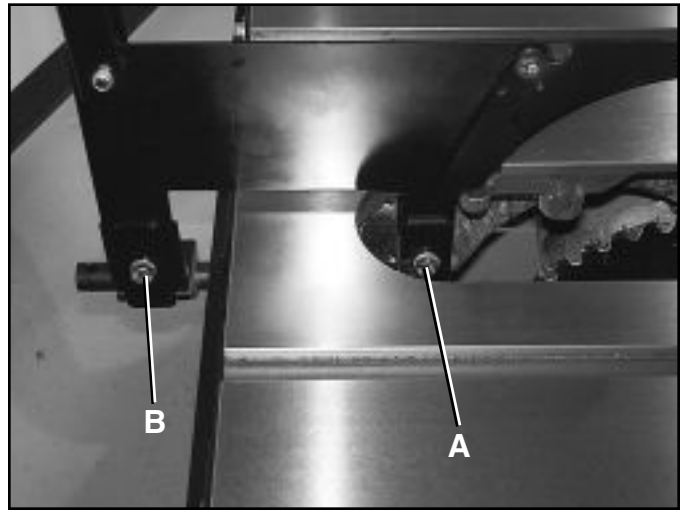

## INSTALLING BLADE

### **⚠ WARNING**

**MAKE CERTAIN THAT THE SAW IS DISCONNECTED FROM THE POWER SOURCE.**

1. Raise the blade arbor fully, set the bevel angle at zero, and lock the arbor by tightening the lock knob in the middle of the handwheel.
2. Remove the arbor nut and flange.
3. Place the blade on the arbor shaft, making sure the teeth point down at the front of the saw. Replace the flange (A) and the arbor nut (B). **SEE FIG. 6.**
4. Using the wrenches provided, securely tighten the arbor nut. Remove the wrenches.

Fig. 6

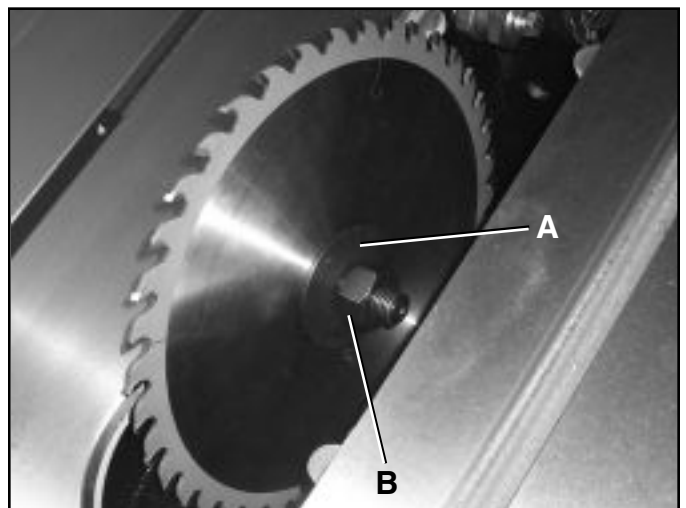

# ADJUSTMENTS

## ALIGNING BLADE GUARD AND SPLITTER

### ⚠ WARNING

MAKE CERTAIN THAT THE SAW IS DISCONNECTED FROM THE POWER SOURCE.

Fig. 7

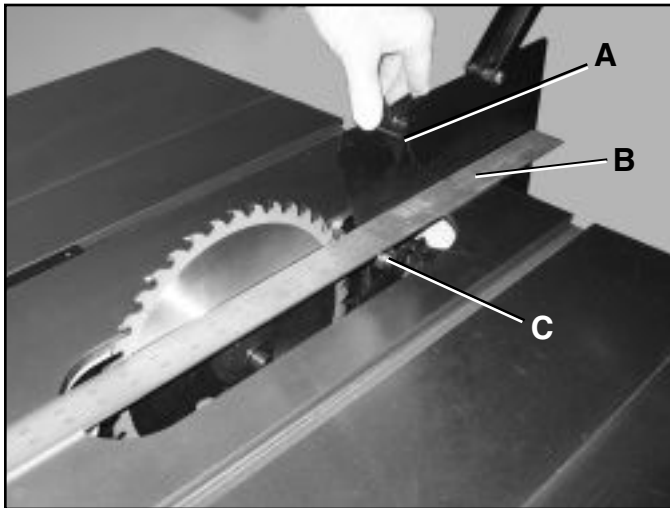

1. Raise blade guard away from table and hold anti-kickback fingers (A) away from table surface. **SEE FIG. 7.**
2. Using an accurate straight edge (B), align the splitter with the saw blade. Be sure the straight edge rests against body of saw blade and not saw teeth.
3. When saw blade is aligned with the splitter, carefully tighten the hex cap bolt (C) on the splitter bracket assembly inside the saw.
4. Make sure the splitter is level with the table and approximately 1/8" above the table before tightening the hardware on the rear of the blade guard assembly. This space between the splitter and the table keeps the splitter from binding on the table when the blade is tilted to 45°.
5. When saw blade is aligned with the splitter, lower the blade, and tighten all hardware.
6. Check alignment again after tightening hardware. Adjust if necessary.

## TABLE INSERT ADJUSTMENT

### ⚠ WARNING

MAKE CERTAIN THAT THE SAW IS DISCONNECTED FROM THE POWER SOURCE.

Fig. 8

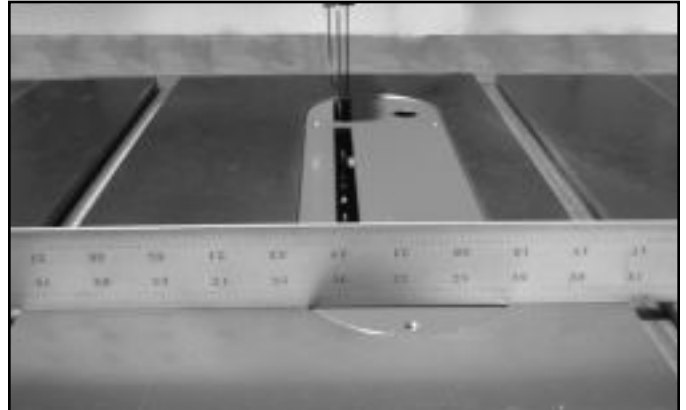

1. Lower blade completely.
2. Place the open end of the insert under the splitter and lower the insert into the opening.
3. Adjust the table insert flush with the table by turning four leveling screws and using a straight edge. **SEE FIG. 8.**

Fig. 9

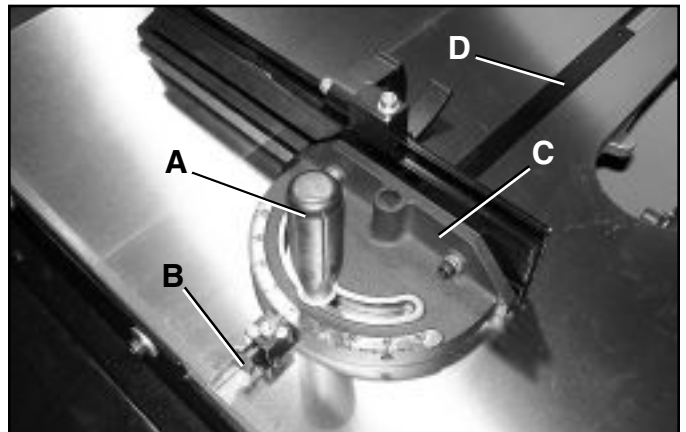

## MITER GAUGE OPERATION

1. Operate Miter gauge by loosening lock knob(A), pull out spring loaded plunger (B) and rotate miter gauge body (C) to desired angle. **SEE FIG 9.**
2. Release plunger and tighten lock knob.
3. Adjust fit of the tie bar (D) in the miter slot by adjusting set screws (not shown) located in the side of the tie bar in or out.

**Note:** Always make test cuts. Do not rely solely on miter gauge indicator marks.

## BLADE RAISING AND TILTING MECHANISM

Fig. 10

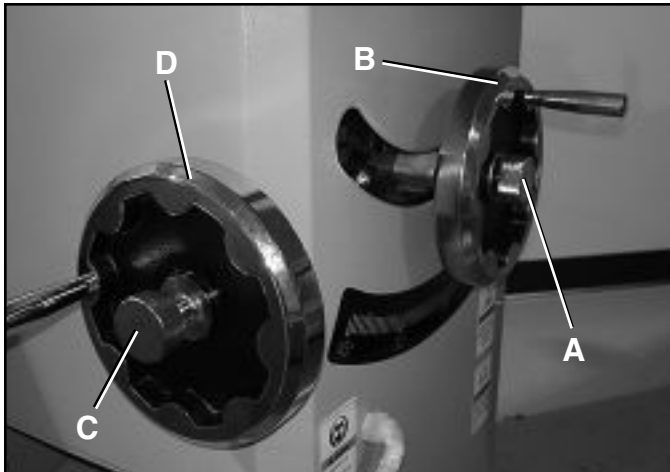

1. To raise or lower the saw blade, loosen the lock knob (A) in the middle of the handwheel and turn the handwheel (B) on the saw front until desired height is reached. Tighten lock knob. **SEE FIG. 10.**
2. To tilt the saw blade, loosen lock knob (C), turn handwheel on the left of the saw cabinet (D) until desired angle is obtained, then tighten lock knob.

## ON/OFF SWITCH

The on and off switch is **thermally protected**. If the saw motor is overloaded, or a momentary interruption of electrical current is sensed, the saw will shut off. Allow a few minutes for the saw to cool down and **reset by pushing the off button (A)**. **SEE FIG. 11.**

Using extension cords can cause a loss in power to your machine. It is best if the saw is plugged directly into an outlet on a dedicated circuit. If using an extension cord, refer to chart in the Grounding Instructions section to determine proper gauge and length.

Fig. 11

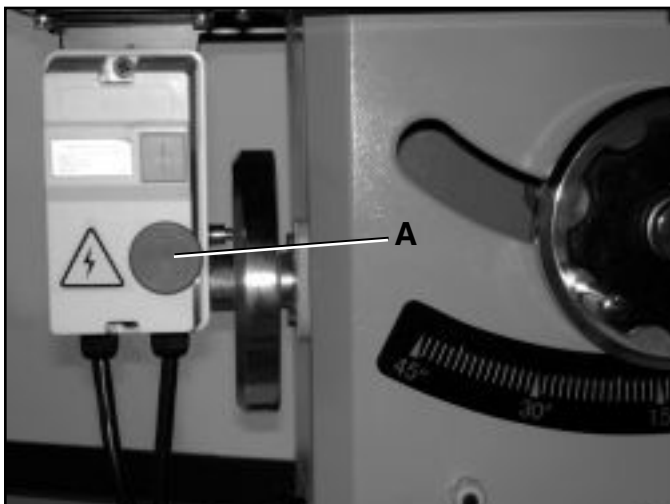

## BLADE ALIGNMENT

Blade alignment with the table is adjusted at the factory. After a period of use, or after moving the saw to another location, the blade may no longer be aligned with the table. To check and align the blade:

### **⚠ WARNING**

**MAKE CERTAIN THAT THE SAW IS DISCONNECTED FROM THE POWER SOURCE.**

Fig. 12

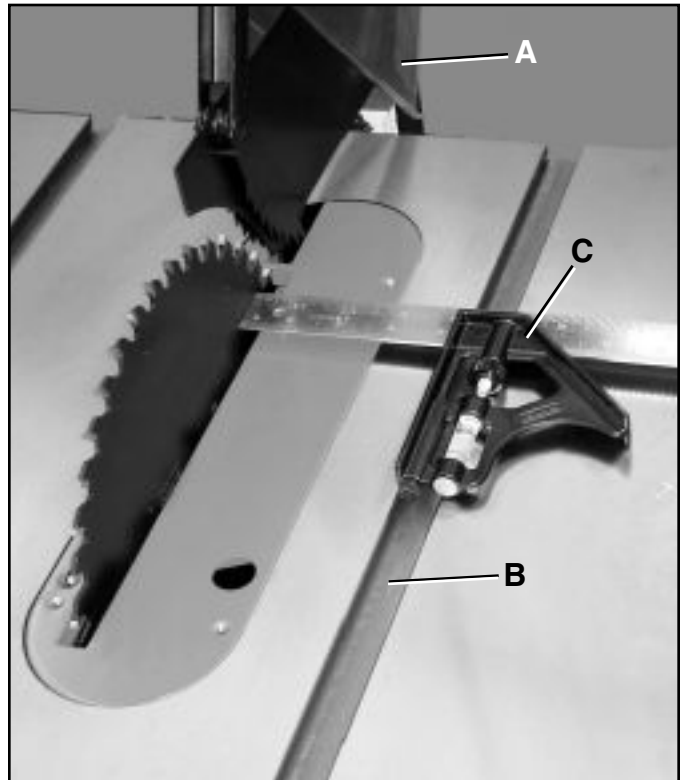

1. Raise the blade guard (A) up and out of the way of the blade. **SEE FIG. 12.**
2. Unlock fence and move away from the blade so as to expose the right miter slot (B).
3. Choose a tooth on the far side of the blade and directly over the insert. Mark the tooth with a marker. Measure the distance from the side of the blade to the right miter slot edge using a combination square (C). Make sure to measure between the teeth, not on the tooth.
4. Rotate the blade toward the front so that the marked tooth is just above the insert. Measure the distance from the side of the blade to the right miter slot edge. The two measurements should be the same.

**Fig. 13**

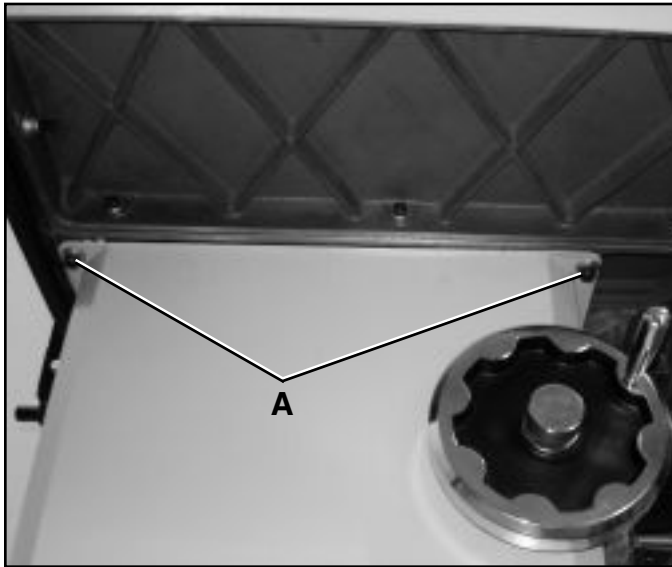

5. If they are not the same, loosen the four socket head cap screws(A) that hold the table to the base. Two are shown in FIG 13, the other two are on the opposite side of the machine. **SEE FIG 13.**
6. Make any needed adjustments and tighten the four hex socket cap screws firmly.
7. Check the alignment once again after tightening hardware.

## **ADJUSTING 45° AND 90° POSITIVE STOPS**

The stops have been adjusted at the factory. After a period of use, or, after moving the saw to another location, the stops may no longer be set properly. To check and adjust the stops:

### **▲ WARNING**

**MAKE CERTAIN THAT THE SAW IS DISCONNECTED FROM THE POWER SOURCE.**

1. Raise the saw blade to its maximum height using the blade height handwheel.
2. Set the blade at 90 degrees to the table by turning the blade tilting handwheel clockwise as far as it will go.
3. Place a square on the table and check to see that the blade is at a 90° angle to the table. Make sure square is not touching a blade tooth. **SEE FIG. 14.**

**Fig. 14**

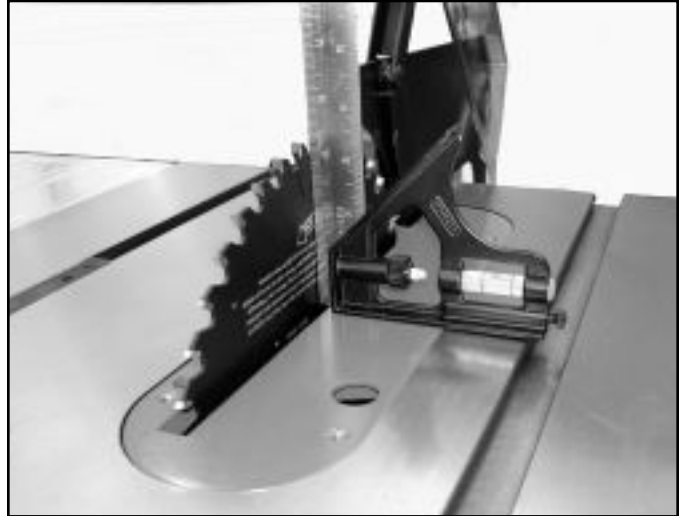

4. If blade is not at 90 degrees, open the motor cover door, loosen lock nut (A) and turn adjusting stop screw (B) on the front trunnion in, or out. The adjusting stop screw should stop against the front trunnion bracket when the blade is 90° to the table. **SEE FIG. 15.**

**Fig. 15**

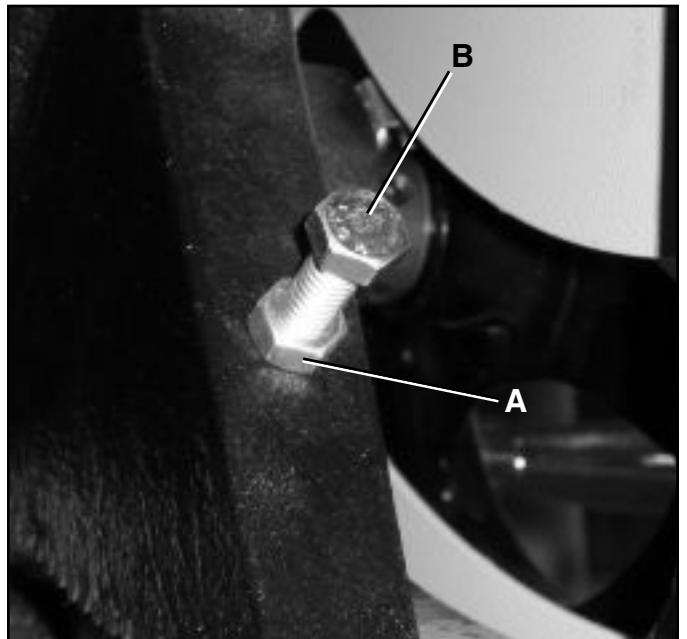

5. Tighten the lock nut (A).
6. Set the blade at 45 degrees to the table by turning the blade tilting handwheel counterclockwise as far as it will go. Place a square on the table. **SEE FIG. 16.**

**Fig. 16**



**Fig. 17**

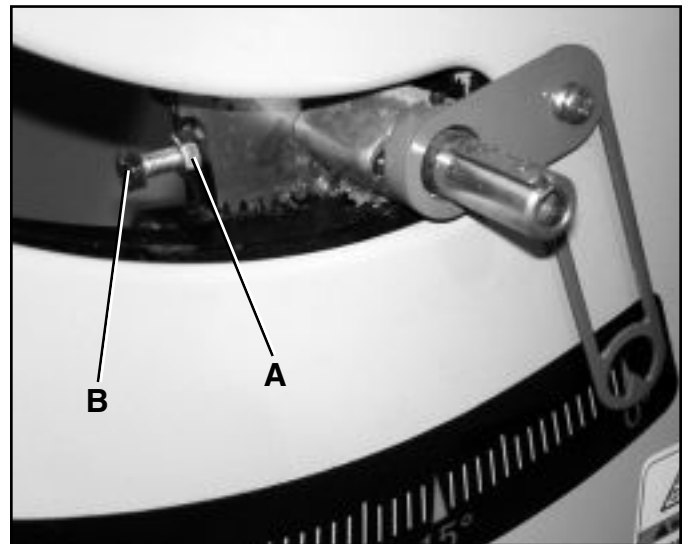

7. If the blade is not at 45 degrees, remove the blade raising and lowering handwheel. Loosen lock nut (A) and turn adjusting stop screw (B) on the front trunnion in, or out. The adjusting stop screw should stop against the front trunnion bracket when the blade is 45° to the table. **SEE FIG. 17.**
8. Check the accuracy of the pointer (C) on the angle scale and adjust, if necessary.

## **MOUNTING RAILS, FENCE AND EXTENSION TABLE**

With the extension wings properly aligned, the rail and fence assembly can now be mounted to the saw. See the Owner's Manual for the Fence Assembly Instructions. This will address the mounting of the rails and fence.

# OPERATIONS

## ⚠ WARNING

**MAKE CERTAIN THAT THE SAW IS DISCONNECTED FROM THE POWER SOURCE.**

## ⚠ WARNING

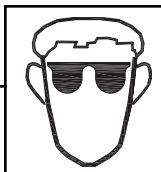

**ALWAYS** wear eye protection. Any machine can throw debris into the eyes during operations, which could cause severe and permanent eye damage. Everyday eyeglasses are **NOT** safety glasses. **ALWAYS** wear Safety Goggles (that comply with ANSI standard Z87.1) when operating power tools.

## ⚠ WARNING

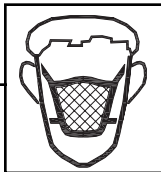

**ALWAYS** wear a NIOSH/OSHA approved dust mask to prevent inhaling dangerous dust or airborne particles.

## ⚠ WARNING

The following section was designed to give instructions on the basic operations of this table saw. However, it is in no way comprehensive of every table saw application. It is strongly recommended that you read books, trade magazines, or get formal training to maximize the potential of your table saw and to minimize the risks.

## PRE-RUN CHECK

### ⚠ WARNING

**MAKE CERTAIN THAT THE SAW IS DISCONNECTED FROM THE POWER SOURCE.**

Before you begin to use your Table Saw, you should give it a thorough inspection, making sure you ask yourself the following questions:

1. Is the blade mounted correctly?
2. Is the saw stable?
3. Is it wired properly?
4. Is the electrical system properly configured?
5. Have you checked your workpiece for obvious defects?
6. Is the guard assembly installed and functional?
7. Have you checked the saw blade clearance when it is adjusted to varying angles and depths?
8. Have you read all the warnings and directions regarding the operation of this machine?

## TEST RUN

1. Face the table saw and stand to the left of the blade path.
2. With one finger on the START button and one finger on the STOP button, turn the saw on. Be ready to turn the saw off in case of a mishap.
3. Watch and listen to the saw. Note whether there are any unusual sounds or excessive vibrations.
4. If anything appears abnormal, immediately turn off the saw, unplug it, and fix the problems. If a problem exists that is beyond the scope of this manual, contact your dealer.
5. If the saw is operating properly, turn it off and prepare to make a cut according to the instructions outlined in this section.

## BLADE SELECTION

Choosing the correct blade for the job is essential for the safe and efficient use of your table saw. Ignoring this important step could result in damage to the saw and serious injury to the operator. Below are the most common saw blades and their uses.

1. **Rip Blade:** Used for cutting with the grain. Typically, 10" rip blades have between 18-40 teeth and large gullets to allow for large chip removal. **SEE FIG. 19.**

**Fig. 19**

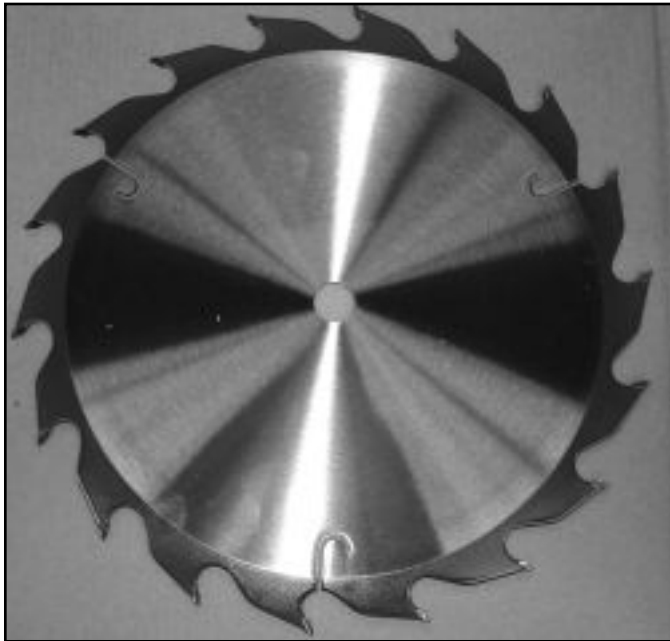

2. **Cross-cut Blade:** Used for cutting across the grain. 10" cross-cut blades have between 60-80 teeth and a shallow gullet. **SEE FIG. 20.**

**Fig. 20**

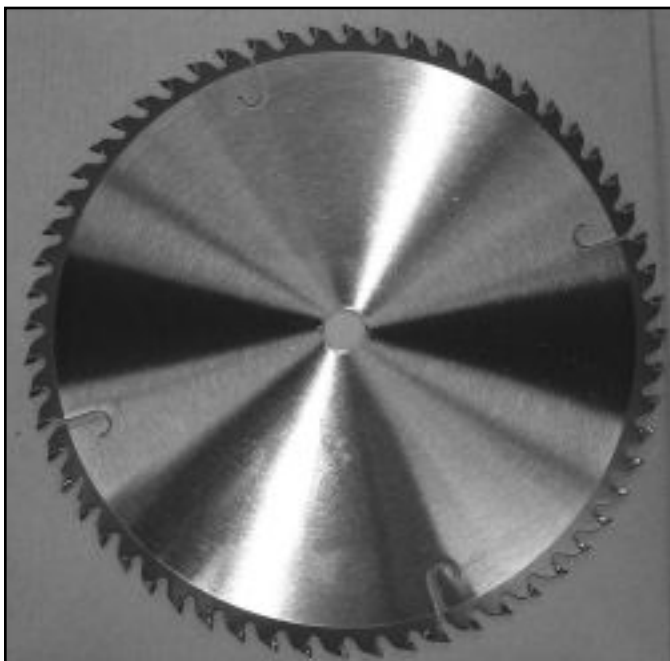

3. **Combination Blade:** Used for cutting with and across the grain. A compromise between a rip blade and a cross-cut blade, a 10" combination blade will typically have between 40-50 teeth. **SEE FIG. 21.**

**Fig. 21**

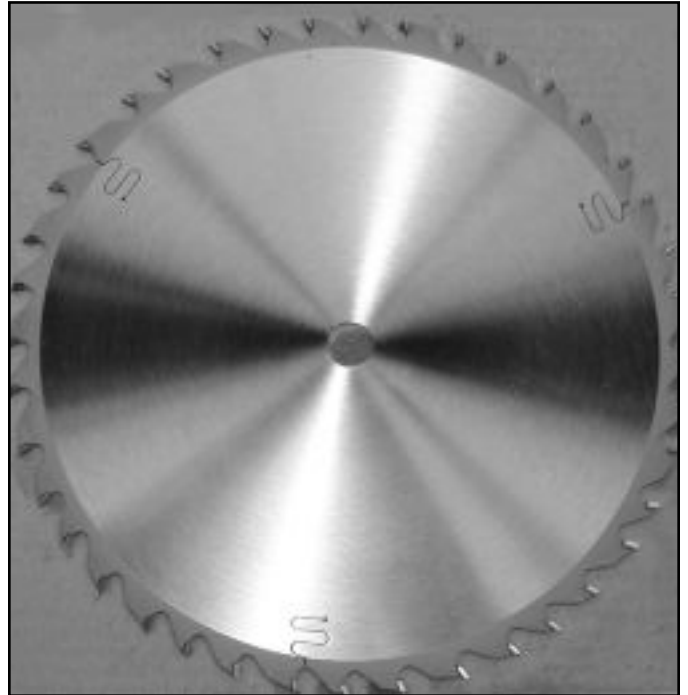

4. **Thin-kerf blade:** Most types of saw blades are available in a thin-kerf style. Designed primarily to minimize stock waste, thin-kerf blades are used in conjunction with a blade stabilizer to reduce blade wobble. **Note:** Many blade guards/splitters are thicker than many thin-kerf blades. Make sure that the stock will pass by the guard/splitter before beginning a cut.
5. **Dado Blades:** There are two types of dado blades: stack and wobble. Stack dados involve more set-up time, but they provide a superior finish cut when compared to a wobble dado. Dado blades require use of accessory dado table insert.
6. **Moulding Heads:** A moulding head is a cutterhead that attaches to the arbor and holds individual moulding knives. They are very dangerous and require training beyond the scope of this manual.

This section on blade selection is by no means comprehensive. Always follow the saw blade manufacturer's recommendations to assure safe and efficient operation of your table saw.



## CROSSCUTTING

Crosscutting means cutting across the grain of the wood. In wood products without grain (i.e. MDF, particleboard), crosscutting simply means cutting across the width of the stock.

Crosscuts are made with the miter gauge. There are two miter gauge slots in the table top. Use the one that works best for the piece being crosscut. **To make a crosscut using the miter gauge:**

1. Inspect the board for soundness. You do not necessarily need a square edge to crosscut with accuracy.
2. Inspect the miter gauge. Is it properly set and tight?
3. Move the rip fence completely out of the way.
4. Turn on the saw and allow it to come to full speed.
5. Hold the workpiece firmly against the face of the miter gauge and ease it into the blade and through the workpiece. **SEE FIG. 22.**

Fig. 22

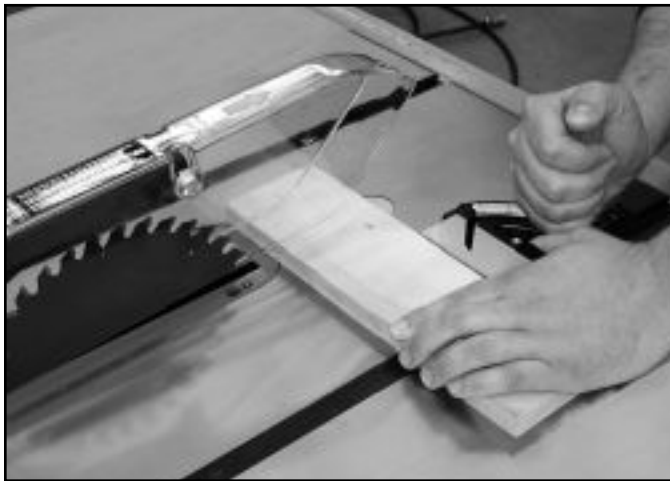

6. Turn off the saw and allow the blade to come to a full stop.

### **⚠ WARNING**

Small cutoff pieces can contact the moving blade and be thrown back toward the operator. Always use the least amount of clearance between the table insert and the blade to reduce the risk of injury from these pieces. Never attempt to grab these pieces while the table saw is turned on. Your hand may come into contact with the blade. Turn the table saw off and safely remove these pieces **AFTER** the blade has come to a complete stop.

## RIPPING

Ripping means to cut with the grain of the wood. In other materials such as MDF or plywood, ripping simply means to cut lengthwise. **To rip a board:**

1. Inspect the board for soundness. You will need a straight edge to rip with accuracy. Your workpiece may need to be jointed flat before attempting to cut on the table saw.

### **⚠ WARNING**

**Never attempt to rip a board that does not have one perfectly straight edge and one flat side on it. Always run the straight edge of the board against the rip fence. Failure to do this could result in kickback and serious personal injury.**

2. Set the rip fence to the desired distance from the blade. **IF YOU ARE MAKING NARROW CUTS, USE A PUSH-STICK.** Serious injury can occur if you put your hands close to the blade. A push-stick pattern has been included at the end of this manual. Use it to hold the workpiece against the table and fence and push the workpiece fully past the blade. When a small width is to be ripped and a push-stick cannot be safely put between the blade and rip fence, rip a larger piece to obtain the desired piece.
3. Turn on the saw and allow it to reach full speed. Place the straight edge of the board against the rip fence and the flat side on the tabletop. Feed the workpiece slowly and evenly into the blade. When ripping, always stand off to the side of the workpiece and push it through, making sure to keep your fingers out of line with the blade. **SEE FIG. 23.**

Fig. 23

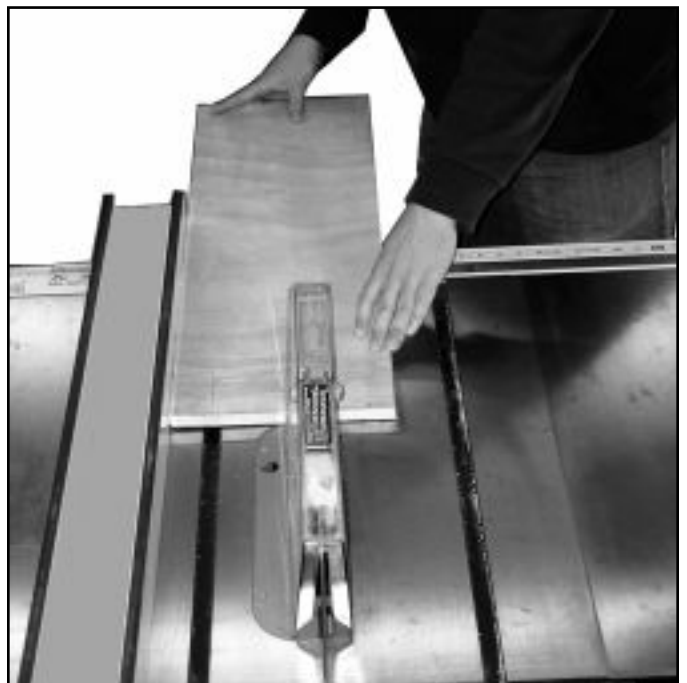

Do not stand directly behind the workpiece when ripping. SEE FIG. 24.

Fig. 24



**▲ WARNING**

Stand out of the line of potential kickback. Hold the workpiece firmly against the fence and table. Do not allow your fingers to get close to the blade! Do not reach over the blade to off-load the workpiece.

## DADO OPERATIONS

In addition to its ability to rip and crosscut lumber, the table saw is also an invaluable tool for creating a variety of dados. These non-through cuts can be created with specially-designed stacking or wobbling dado blades.

**▲ WARNING**

Never allow hands or arms to be above or behind the saw blade. Should kickback occur, the hands and arms can be pulled into the saw blade. Serious injury will result.

**▲ WARNING**

Never perform a through cut operation with a dado blade. A dado blade is designed to make non-through cuts only. Failure to follow these directions could result in serious injury.

**▲ WARNING**

Dado operations present very real hazards requiring proper procedures to avoid serious injury. The chance of kickback is always greater when dado blades are used so extra precautions must be used. Any movement of the stock away from the fence can cause kickback. Be certain that stock is flat and straight. Failure to follow these warnings could result in serious personal injury.

**▲ WARNING**

Always use push sticks, featherboards, push paddles and other safety accessories whenever possible to increase safety and control during operations which require the blade guard and splitter to be removed from the saw. ALWAYS replace the blade guard after dadoing is complete.

Proper dado operations will differ depending on the blade system you choose. Consult the instructions included with your dado blades for directions regarding attachment and adjustment. To use a dado blade:

**▲ WARNING**

**MAKE CERTAIN THAT THE SAW IS DISCONNECTED FROM THE POWER SOURCE.**

1. Remove the table insert, splitter guard, and regular saw blade.
2. Attach and adjust the dado blade system as recommended in the dado blade's instructions.
3. Install the dado table insert.
4. Raise the blade system up to the desired depth of the dado. Make sure the dado blade will not cut through the workpiece.
5. Reconnect the saw to the power source.
- 6.. If dadoing along the length of your workpiece, adjust the distance between the fence and the inside edge of the blade to suit your needs. When cutting across the wood grain, use the miter gauge as a guide while dadoing. **Remember:** Never use the fence as a stop in conjunction with your miter gauge.
7. Using a scrap piece as a test piece, switch on the saw and take a pass over the dado blade.
8. If the cut is satisfactory, repeat with your finish stock.
9. Avoid taking too deep a cut in a single pass. Make incremental cuts to avoid kickback.

# MAINTENANCE

This table saw requires very little maintenance other than minor lubrication and cleaning. The following sections detail what will need to be done in order to assure continued operation of your saw.

## **⚠ WARNING**

**MAKE CERTAIN THAT THE SAW IS DISCONNECTED FROM THE POWER SOURCE.**

## LUBRICATION

The table saw has sealed lubricated bearings in the motor housing and the arbor assembly that do not require any additional lubrication from the operator.

Use a wire brush to clean off the worm gears and trunnions and apply a white lithium grease to keep them lubricated.

## CLEANING

Keep the inside of the cabinet clear of saw dust and wood chips. With the table saw unplugged, vacuum out the inside of the cabinet or blow out the inside with an air hose. Be sure to use air pressure no higher than 50 P.S.I. as high pressure air may damage insulation.

## **⚠ WARNING**

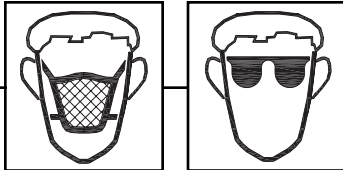

Be sure to wear protective eyewear and dust mask when cleaning out the cabinet of the saw.

## MODEL 35620 ONLY

The tabletop is an unfinished metal surface that, over time, will accumulate rust if not properly cared for. When the table saw is not in use, keep a light coat of WD-40 on the table top as this will help prevent rust from occurring. If rust has already accumulated on the table, use WD-40 and a fine steel wool to get rid of the rust. Using a quality paste wax on the tabletop and wings is a good preventative measure to help prevent rust from forming.

## MODEL 35631 ONLY

The table top is designed to be maintenance free and, under normal shop conditions, the Titanium Nitrite (TiN) coating will minimize the chance of rust forming on the table top. While the distinctive gold color of your Steel City cast-iron top is an indication that the surface is protected against rust and corrosion, that protection does not diminish if the gold color is worn away by abrasion due to normal use over time. A paste wax may be applied to the table top to give it a shiny appearance.

## CHANGING BELTS

## **⚠ WARNING**

**MAKE CERTAIN THAT THE SAW IS DISCONNECTED FROM THE POWER SOURCE.**

Fig. 1

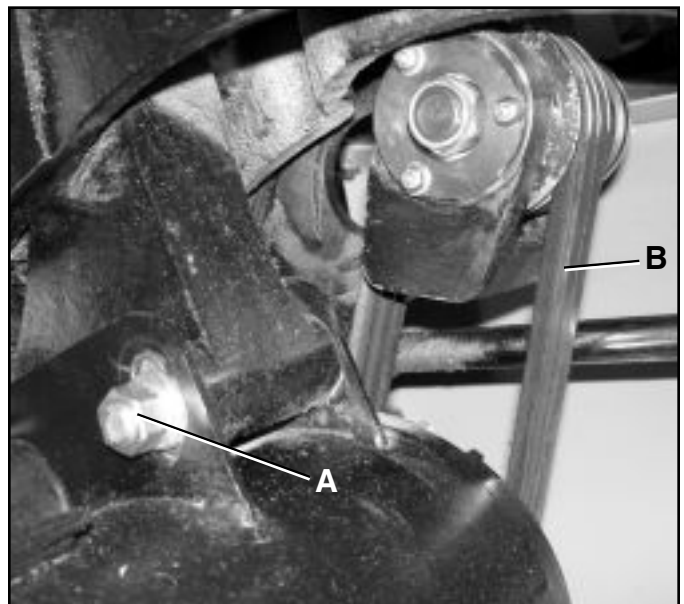

1. Lower the blade to its lowest point.
2. Loosen the hex cap bolt (A). **SEE FIG. 1.**
3. Take the tension off of the belts (B) by lifting up on the motor.
4. Remove the belts from the arbor and motor pulleys.
5. Replace and tension the belts. The weight of the motor should apply enough tension to the belts. Tighten the hex cap bolts.
6. Check the belt tension after the saw has been used for a few hours. Adjust as necessary.

# TROUBLESHOOTING GUIDE

This section covers the most common processing problems encountered in sawing and what to do about them. Do not make any adjustments until the table saw is unplugged from the power source and moving parts have come to a complete stop.

PROBLEM	LIKELY CAUSE(S)	SOLUTION
<b>Saw stops or will not start.</b>	<ol style="list-style-type: none"> <li>1. Overload tripped.</li> <li>2. Saw unplugged from wall or motor.</li> <li>3. Fuse blown or circuit breaker tripped.</li> <li>4. Cord damaged</li> </ol>	<ol style="list-style-type: none"> <li>1. Allow motor to cool and reset by pushing off switch.</li> <li>2. Check all plug connections.</li> <li>3. Replace fuse or reset circuit breaker.</li> <li>4. Replace cord.</li> </ol>
<b>Does not make accurate 45° or 90° cuts.</b>	<ol style="list-style-type: none"> <li>1. Miter slot not parallel to the blade.</li> <li>2. Angle pointer not set accurately.</li> <li>3. Miter gauge out of adjustment.</li> </ol>	<ol style="list-style-type: none"> <li>1. Check blade with square.</li> <li>2. Check blade with square and adjust pointer.</li> <li>3. Adjust miter gauge.</li> </ol>
<b>Material binds blade when ripping.</b>	<ol style="list-style-type: none"> <li>1. Fence not aligned with blade.</li> <li>2. Warped wood.</li> <li>3. Excessive feed rate.</li> <li>4. Splitter not aligned with blade</li> </ol>	<ol style="list-style-type: none"> <li>1. Check and adjust fence.</li> <li>2. Select another piece of wood.</li> <li>3. Reduce feed rate.</li> <li>4. Align splitter with blade.</li> </ol>
<b>Saw makes unsatisfactory cuts.</b>	<ol style="list-style-type: none"> <li>1. Dull blade.</li> <li>2. Blade mounted backwards.</li> <li>3. Gum or pitch on blade</li> <li>4. Incorrect blade for cut.</li> <li>5. Gum or pitch on table.</li> </ol>	<ol style="list-style-type: none"> <li>1. Sharpen or replace blade.</li> <li>2. Properly mount the blade.</li> <li>3. Remove blade and clean.</li> <li>4. Change blade to correct type.</li> <li>5. Clean table.</li> </ol>
<b>Blade does not come up to speed.</b>	<ol style="list-style-type: none"> <li>1. Extension cord too light or too long.</li> <li>2. Low shop voltage.</li> <li>3. Motor not wired for correct voltage.</li> </ol>	<ol style="list-style-type: none"> <li>1. Replace with adequate size cord.</li> <li>2. Contact your local electric company.</li> <li>3. Refer to motor junction box.</li> </ol>
<b>Saw vibrates excessively.</b>	<ol style="list-style-type: none"> <li>1. Stand on uneven floor.</li> <li>2. Damaged saw blade.</li> <li>3. Bad V-belts.</li> <li>4. Bent pulley.</li> <li>5. Improper motor mounting.</li> <li>6. Loose hardware.</li> <li>7. Loose set screw in pulley.</li> </ol>	<ol style="list-style-type: none"> <li>1. Reposition on flat, level surface.</li> <li>2. Replace saw blade.</li> <li>3. Replace V-belts.</li> <li>4. Replace pulley.</li> <li>5. Check and adjust motor.</li> <li>6. Tighten hardware.</li> <li>7. Tighten set screw.</li> </ol>
<b>Rip fence binds on guide rails.</b>	<ol style="list-style-type: none"> <li>1. Guide rails or extension wing not installed correctly.</li> <li>2. Guide of rip fence not adjusted properly.</li> </ol>	<ol style="list-style-type: none"> <li>1. Reassemble guide rails, refer to fence manual.</li> <li>2. Adjust guides, refer to fence manual.</li> </ol>
<b>Material kicked back from blade.</b>	<ol style="list-style-type: none"> <li>1. Rip fence out of alignment.</li> <li>2. Splitter not aligned with blade.</li> <li>3. Feeding stock without rip fence.</li> <li>4. Splitter not in place.</li> <li>5. Dull blade.</li> <li>6. Letting go of material before it is past blade.</li> <li>7. Anti-kickback fingers dull.</li> </ol>	<ol style="list-style-type: none"> <li>1. Align rip fence with miter slot and blade.</li> <li>2. Align splitter with blade.</li> <li>3. Install and use rip fence.</li> <li>4. Install and use splitter (with guard).</li> <li>5. Replace blade.</li> <li>6. Push material all the way past blade before releasing work.</li> <li>7. Replace or sharpen anti-kickback fingers.</li> </ol>
<b>Blade does not raise or tilt freely.</b>	<ol style="list-style-type: none"> <li>1. Sawdust and debris in raising and tilting mechanisms.</li> </ol>	<ol style="list-style-type: none"> <li>1. Clean and grease.</li> </ol>

# ◆ NOTES ◆

# PARTS

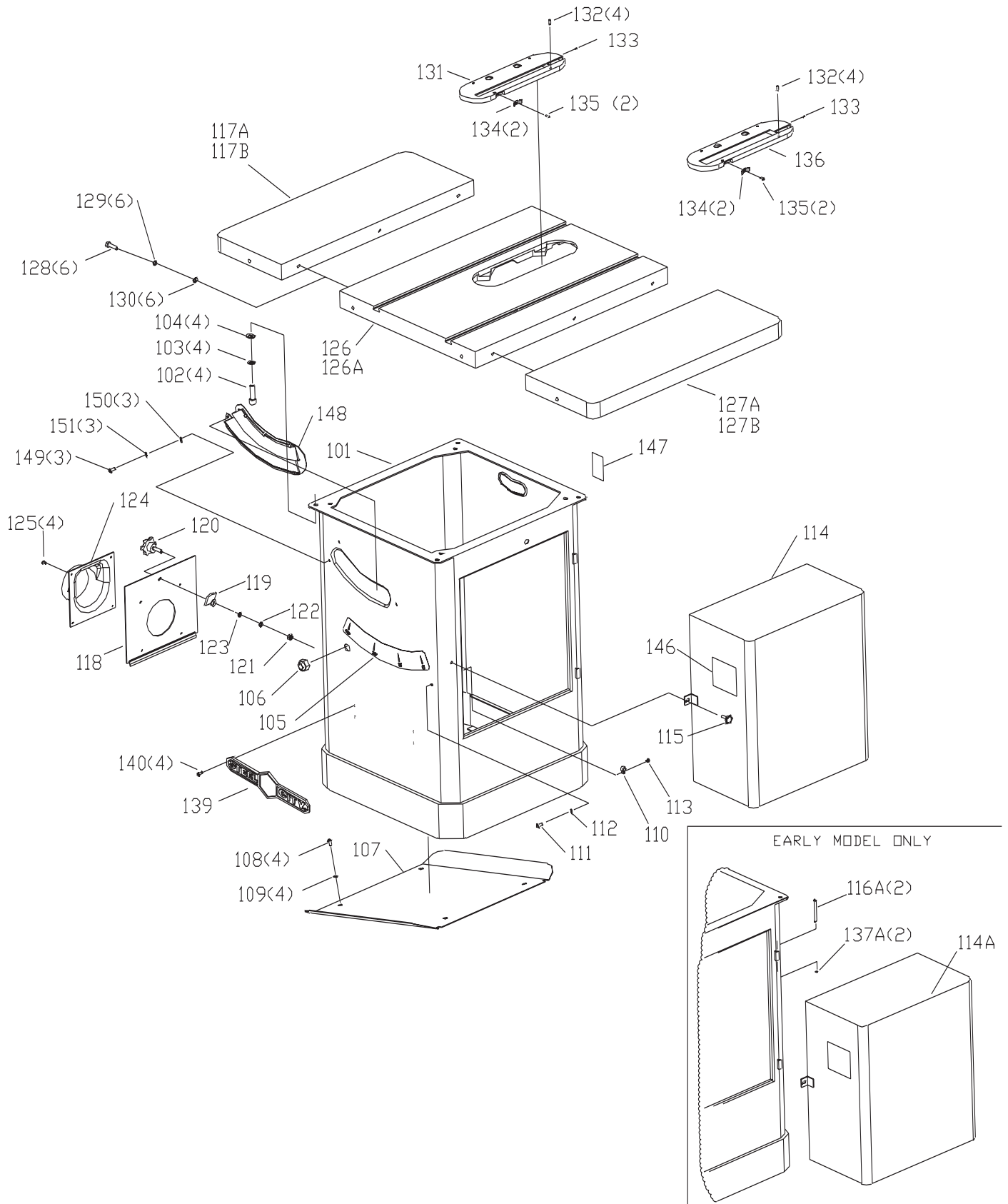

KEY NO.	PART NO.	DESCRIPTION	QTY.	KEY NO.	PART NO.	DESCRIPTION	QTY.
101	OR70694	CABINET	1	124	OR70705	DUST HOOD	1
102	OR93932	M10 x 25mm SOC HEAD CAP SCREW	4	125	OR90507	M5 x 8mm PAN HEAD SCREW	4
103	OR90227	M10 LOCK WASHER	4	126	OR70706	TABLE	1
104	OR90230	M10 FLAT WASHER	4	126A	OR70707	TABLE (TITANIUM FINISH)	1
105	OR70695	BEVEL SCALE	1	127A	OR70708	EXTENSION WING,RIGHT 10"	1
106	OR70696	INSULATOR	1	127B	OR70709	EXTENSION WING,RIGHT 10" (TITANIUM FINISH)	1
107	OR70697	DUST CHUTE	1	128	OR90308	M8 x 30mm HEX HEAD SCREW	6
108	OR90320	M6 x 12mm PAN HEAD SCREW	4	129	OR90248	M8 LOCK WASHER	6
109	OR90059	M6 FLAT WASHER	4	130	OR90311	M8 FLAT WASHER	6
110	OR70698	CABLE CLAMP	1	131	OR70710	TABLE INSERT	1
111	OR90867	M5 x 10mm PAN HEAD SCREW	1	132	OR90253	M5 x 12mm HEX SOC SET SCREW	8
112	OR90462	M5 FLAT WASHER	1	133	OR93905	SPRING PIN	2
113	OR93933	M5 NYLOK NUT	1	134	OR70711	SPRING CLIP	4
114	OR73641	MOTOR COVER (CURRENT MODEL) SEE NOTE:1	1	135	OR91774	M4 x 10mm PAN HEAD SCREW	4
114A	OR70699	MOTOR COVER (EARLY MODEL ONLY) SEE NOTE:1	1	136	OR70712	DADO TABLE INSERT	1
115	OR70700	KNOB	1	137A	OR93934	CIRCLIP (EARLY MODEL ONLY) SEE NOTE:1	2
116A	OR70701	PIN (EARLY MODEL ONLY) SEE NOTE:1	2	139	OR70484	NAMEPLATE	1
117A	OR73303	EXTENSION WING,LEFT 10"	1	140	OR93823	RIVET	4
117B	OR73304	EXTENSION WING,LEFT 10" (TITANIUM FINISH)	1	146	OR70713	WARNING LABLE	1
118	OR70702	DUST CHUTE DOOR	1	147	OR70320	SPEC PLATE	1
119	OR70703	DOOR LATCH	1	148	OR71405	DUST CLIP	1
120	OR70704	KNOB	1	149	OR91774	M4 x 10mm PAN HEAD SCREW	3
121	OR90307	M8 HEX NUT	1	150	OR90079	M4 FLAT WASHER	3
122	OR90248	M8 LOCK WASHER	1	151	OR90077	M4 LOCK WASHER	3
123	OR90311	M8 FLAT WASHER	1				

**NOTE: 1** Current model REF. 114 has hinge pin installed as part of the motor cover.  
Early model REF. 114A hinge pin is separate from the motor cover. Requires REF. 116A; 137A.

EARLY MODEL ARBOR ASSY  
 ARBOR SHAFT=17MM DIA.

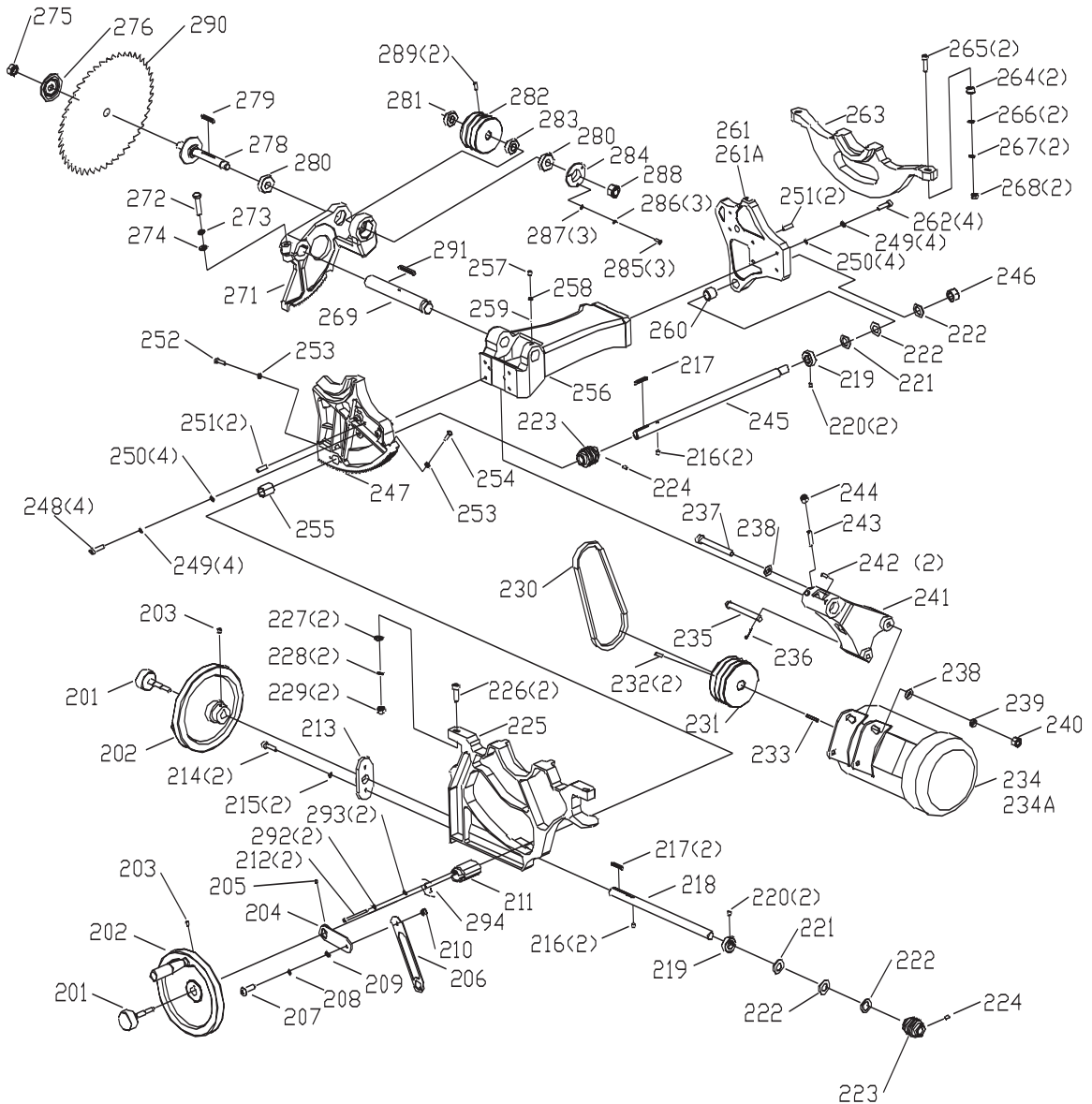
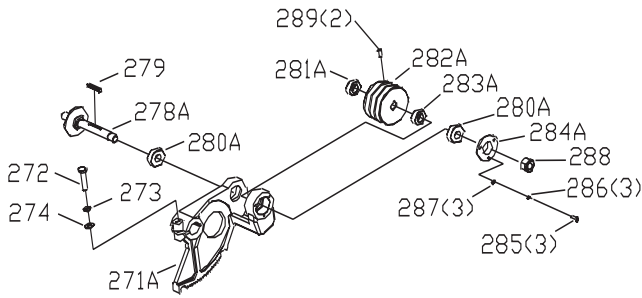



KEY NO.	PART NO.	DESCRIPTION	QTY.	KEY NO.	PART NO.	DESCRIPTION	QTY.
201	OR70714	HAND WHEEL LOCK	2	258	OR93919	SPRING	1
202	OR70715	HAND WHEEL ASSEMBLY	2	259	OR93920	BALL	1
203	OR94167	M6 x 8mm HEX SOC SET SCREW	2	260	OR70735	BUSHING	1
204	OR70716	POINTER MOUNT	1	261	OR73642	REAR TRUNNION (CURRENT MODEL) SEE NOTE:2	1
205	OR93906	M5 x 6mm HEX SOC SET SCREW	1	261A	OR70736	REAR TRUNNION (EARLY MODEL) SEE NOTE:2	1
206	OR70717	POINTER	1	262	OR92174	M8 x 30mm SOC HEAD CAP SCREW	4
207	OR90306	M6 x 12mm PAN HEAD SCREW	1	263	OR70737	REAR TRUNNION BRACKET	1
208	OR90502	M6 LOCK WASHER	1	264	OR70738	ADJUSTMENT BUSHING	2
209	OR90059	M6 FLAT WASHER	1	265	OR92174	M8 x 30mm SOC HEAD CAP SCREW	2
210	OR90235	M6 HEX NUT	1	266	OR90311	M8 FLAT WASHER	2
211	OR70718	POINTER BRACKET	1	267	OR90248	M8 LOCK WASHER	2
212	OR93907	M5 x 45mm SOC HEAD CAP SCREW	2	268	OR90307	M8 HEX NUT	2
213	OR70719	TILT PLATE	1	269	OR70739	ELEVATING BRACKET SHAFT	1
214	OR92174	M8 x 30mm SOC HEAD CAP SCREW	2	270	OR73643	ARBOR BRACKET ASSY(CURRENT MODEL), CONST OF: REF 271 TO REF 289 SEE NOTE:3	1
215	OR90248	M8 LOCK WASHER	2	271	OR73644	ELEVATING BRACKET SEE NOTE:3	1
216	OR70720	SHAFT LOCK PIN	4	272	OR91746	M10 x 45mm HEX HEAD SCREW	1
217	OR91770	5mm x 5mm x 36mm KEY	2	273	OR90227	M10 LOCK WASHER	1
218	OR70721	BEVEL SHAFT	1	274	OR90230	M10 FLAT WASHER	1
219	OR70722	LOCK COLLAR	2	275	OR73645	ARBOR NUT SEE NOTE:3	1
220	OR91816	M6 x 8mm HEX SOC SET SCREW	4	276	OR73646	ARBOR FLANGE SEE NOTE:3	1
221	OR70723	SPECIAL WASHER	2	278	OR73647	ARBOR SEE NOTE:3	1
222	OR70724	BRONZE WASHER	4	279	OR90219	5mm x 5mm x 30mm KEY	1
223	OR70725	WORM GEAR	2	280	OR73648	BEARING (6005Z) SEE NOTE:3	2
224	OR90222	M6 x 10mm HEX SOC SET SCREW	2	281	OR73649	ARBOR SPACER SEE NOTE:3	1
225	OR70726	FRONT TRUNNION BRACKET	1	282	OR73650	ARBOR PULLEY SEE NOTE:3	1
226	OR93908	M10 x 30mm SOC HEAD CAP SCREW	2	283	OR73651	ARBOR SPACER SEE NOTE:3	1
227	OR90230	M10 FLAT WASHER	2	284	OR73652	BEARING KEEPER SEE NOTE:3	1
228	OR90227	M10 LOCK WASHER	2	285	OR92137	M5 x 12mm PAN HEAD SCREW	3
229	OR90228	M10 HEX NUT	2	286	OR90145	M5 LOCK WASHER	3
230	OR70727	BELT	3	287	OR90462	M5 FLAT WASHER	3
231	OR70728	MOTOR PULLEY	1	288	OR93922	M16 NYLOK NUT	1
232	OR90253	M5 x 12mm HEX SOC SET SCREW	2	289	OR90253	M5 x 12mm HEX SOC SET SCREW	2
233	OR93909	KEY	1	270A	OR70935	ARBOR BRACKET ASSY (EARLY MODEL), CONST OF: REF 271 TO REF 289 SEE NOTE:3	1
234	OR70425	MOTOR (3HP, 230 VAC, 1 PHASE)	1	271A	OR70740	ELEVATING BRACKET SEE NOTE:3	1
234A	OR70372	MOTOR SPEC PLATE	1	272	OR91746	M10 x 45mm HEX HEAD SCREW	1
235	OR70729	MOTOR PIVOT PIN	1	273	OR90227	M10 LOCK WASHER	1
236	OR93910	HITCH PIN	1	274	OR90230	M10 FLAT WASHER	1
237	OR93911	M12 x 100mm HEX HEAD SCREW	1	275	OR70741	ARBOR NUT SEE NOTE:3	1
238	OR90304	M12 FLAT WASHER	2	276	OR70742	ARBOR FLANGE SEE NOTE:3	1
239	OR93912	M12 LOCK WASHER	1	278A	OR70744	ARBOR SEE NOTE:3	1
240	OR90280	M12 HEX NUT	1	279	OR90219	5mm x 5mm x 30mm KEY	1
241	OR70730	MOTOR MOUNT	1	280A	OR90218	BEARING (6203Z) SEE NOTE:3	2
242	OR93913	M8 x 12mm HEX SOC SET SCREW	2	281A	OR70745	ARBOR SPACER SEE NOTE:3	1
243	OR93914	M8 x 30mm HEX SOC SET SCREW	1	282A	OR70746	ARBOR PULLEY SEE NOTE:3	1
244	OR90307	M8 HEX NUT	1	283A	OR70747	ARBOR SPACER SEE NOTE:3	1
245	OR70731	RAISE / LOWER SHAFT	1	284A	OR70748	BEARING KEEPER SEE NOTE:3	1
246	OR93915	M18 NYLOK NUT	1	285	OR92137	M5 x 12mm PAN HEAD SCREW	3
247	OR70732	FRONT TRUNNION	1	286	OR90145	M5 LOCK WASHER	3
248	OR92174	M8 x 30mm SOC HEAD CAP SCREW	4	287	OR90462	M5 FLAT WASHER	3
249	OR90248	M8 LOCK WASHER	8	288	OR93922	M16 NYLOK NUT	1
250	OR90311	M8 FLAT WASHER	8	289	OR90253	M5 x 12mm HEX SOC SET SCREW	2
251	OR93916	8mm x 40mm SPRING PIN	4	290	OR70400	BLADE	1
252	OR93917	M8 x 20mm HEX HEAD SCREW	1	291	OR93921	6mm x 6mm X 50mm KEY	1
253	OR90307	M8 HEX NUT	2	292	OR90145	M5 LOCK WASHER	2
254	OR93918	M8 x 16mm HEX HEAD SCREW	1	293	OR90462	M5 FLAT WASHER	2
255	OR70733	BUSHING	1	294	OR71406	DUST RING	1
256	OR70734	TRUNNION SUPPORT BRACKET	1				
257	OR90283	M8 x 8mm HEX SOC SET SCREW	1				

**NOTE: 2** Current model REF 261 has a threaded hole for REF. 308. Requires REF. 301  
Early model REF. 261A has a clearance hole for REF. 308A. Requires REF. 301A; 309A.

**NOTE: 3** Current model REF. 270 has a 25mm diameter arbor shaft. Requires REF. 271; 289.  
Early model REF. 270A has a 17mm diameter arbor shaft. Requires REF. 271A; 278A; 280A; 281A;  
282A; 283A; 284A.

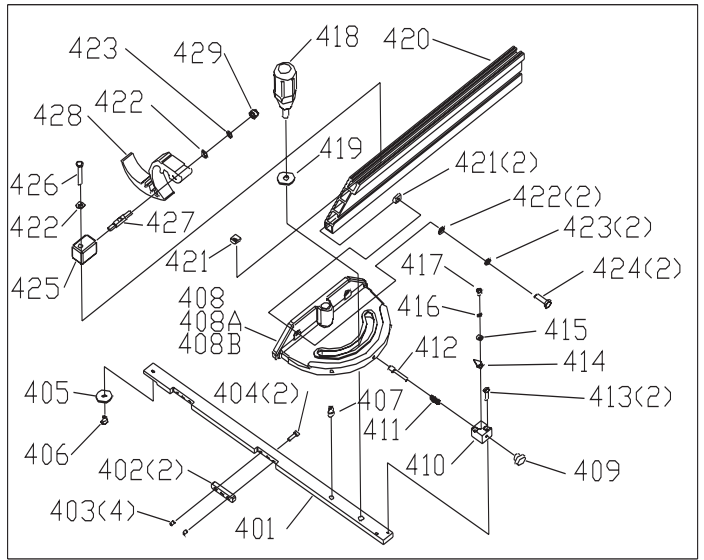
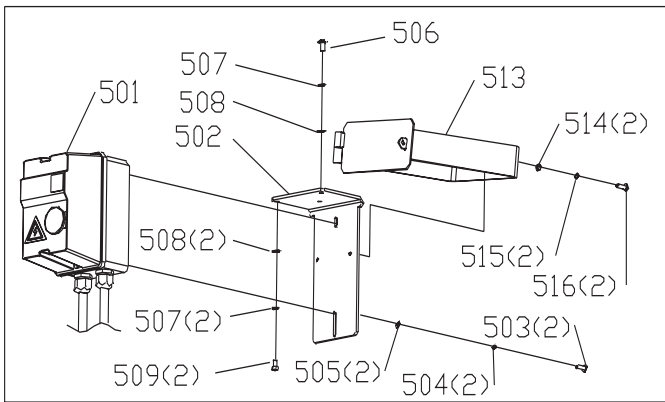
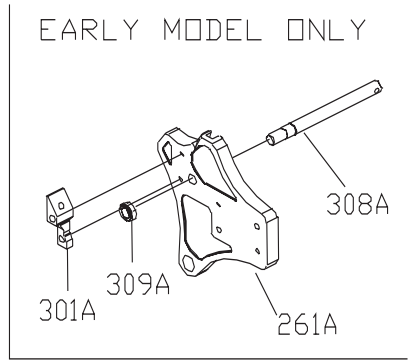
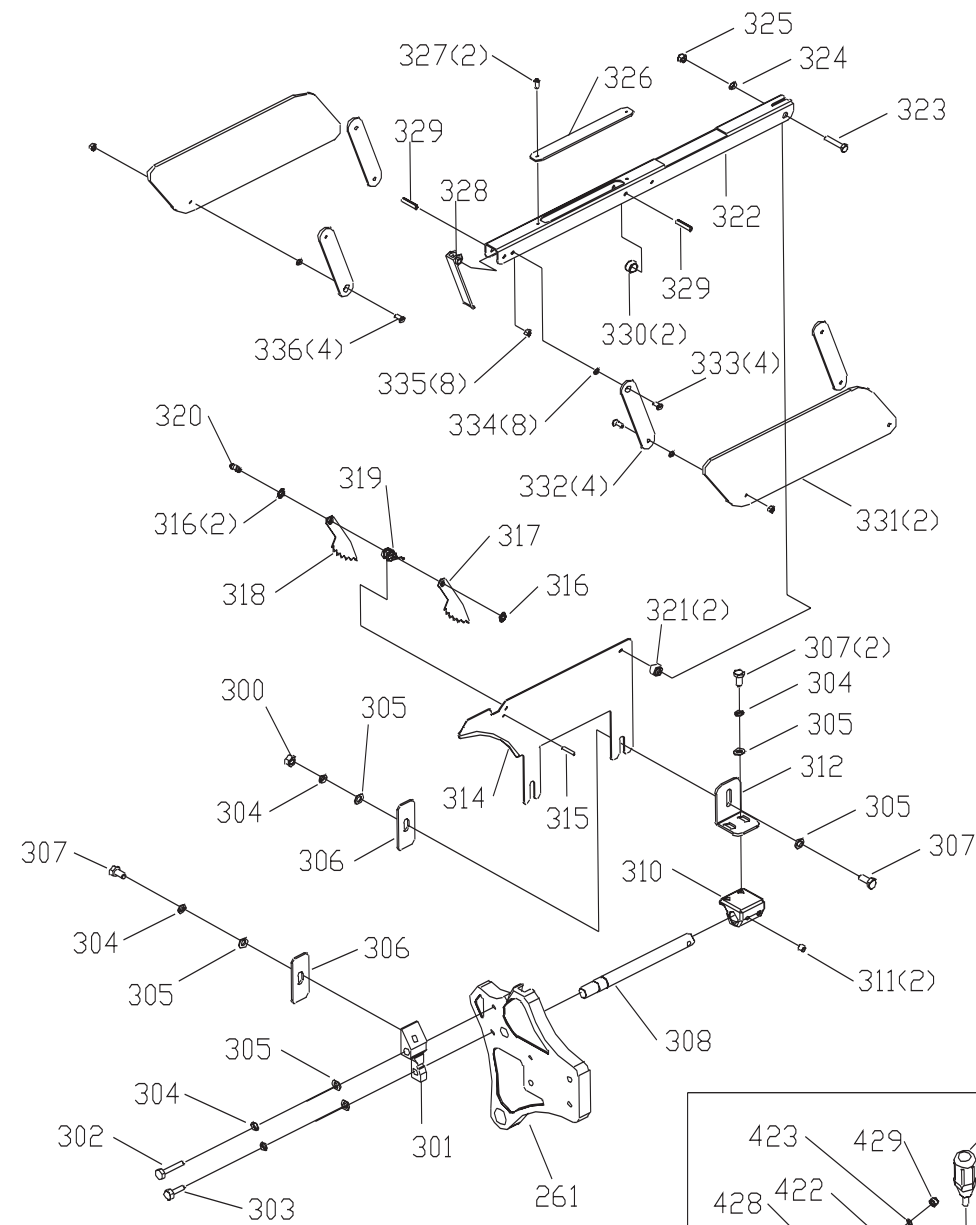

KEY NO.	PART NO.	DESCRIPTION	QTY.	KEY NO.	PART NO.	DESCRIPTION	QTY.
300	OR90307	M8 HEX NUT	1	400	OR70788	MITER GAGE ASSY, CONST OF: REF 401 TO REF 429	1
301	OR73653	SUPPORT BRACKET (CURRENT MODEL) SEE NOTE:2	1	401	OR70766	MITER GAGE BAR	1
301A	OR70749	SUPPORT BRACKET (EARLY MODEL) SEE NOTE:2	1	402	OR70767	MITER GAGE BAR ADJUSTMENT BLOCK	2
302	OR93923	M8 x 40mm SOC HEAD CAP SCREW	1	403	OR90056	M4 x 6mm HEX SOC SET SCREW	4
303	OR91806	M8 x 25mm SOC HEAD CAP SCREW	1	404	OR92717	M4 x 14mm HEX SOC HD CAP SCREW	2
304	OR90248	M8 LOCK WASHER	6	405	OR70768	SPECIAL WASHER	1
305	OR90311	M8 FLAT WASHER	7	406	OR93926	M5 x 8mm FLAT HEAD SCREW	1
306	OR70750	LOCK PLATE	2	407	OR70769	MITER GAGE PIN	1
307	OR90308	M8 x 20mm HEX HEAD SCREW	4	408	OR73655	MITER GAGE BODY ASSY CONST OF: REF. 408,408A 408B (REPLACES EARLY MODEL OR70770)	1
308	OR73654	BLADE GUARD SUPPORT SHAFT (CURRENT MODEL) SEE NOTE:2	1	408A	OR73656	MITER SCALE	1
308A	OR70751	BLADE GUARD SUPPORT SHAFT (EARLY MODEL) SEE NOTE:2	1	408B	OR73657	RIVET	4
309A	OR93922	M16 NYLOK NUT (EARLY MODEL ONLY) SEE NOTE:2	1	409	OR70771	MITER GAGE DETENT PIN KNOB	1
310	OR70752	LOWER BLADE GUARD BRACKET	1	410	OR70772	MITER GAGE DETENT BLOCK	1
311	OR90283	M8 x 8mm HEX SOC SET SCREW	2	411	OR93927	SPRING	1
312	OR70753	UPPER BLADE GUARD BRACKET	1	412	OR70773	DETENT PIN	1
313	OR70784	SPLITTER ASSY, CONST OF: REF 314 TO REF 336	1	413	OR93928	M4 x 20mm FLAT HEAD SCREW	2
314	OR70754	SPLITTER	1	414	OR70774	POINTER MITER GAUGE	1
315	OR94166	4mm x 20mm SPRING PIN	1	415	OR90143	M4 FLAT WASHER	1
316	OR93924	PUSH NUT	2	416	OR90077	M4 LOCK WASHER	1
317	OR70755	RIGHT ANTI - KICKBACK FINGER ASSY	1	417	OR90346	M4 x 8mm PAN HEAD SCREW	1
318	OR70756	LEFT ANTI - KICKBACK FINGER ASSY	1	418	OR70775	MITER GAGE KNOB	1
319	OR70757	SPRING	1	419	OR70776	SPECIAL WASHER	1
320	OR70758	SPRING PIN	1	420	OR70777	MITER GAGE FENCE	1
321	OR70759	SPACER	2	421	OR93929	M6 SQUARE NUT	2
322	OR70760	SUPPORT ARM	1	422	OR90059	M6 FLAT WASHER	4
323	OR91750	M6 x 35mm HEX HEAD SCREW	1	423	OR90502	M6 LOCK WASHER	3
324	OR90059	M6 FLAT WASHER	1	424	OR91749	M6 x 20mm HEX HEAD SCREW	2
325	OR91754	M6 NYLOK NUT	1	425	OR70778	FLIP STOP BLOCK	1
326	OR70761	SEE-THRU TOP PLATE	1	426	OR92723	M6 x 40mm HEX HEAD SCREW	1
327	OR90135	M4 x 6mm PAN HEAD SCREW	2	427	OR70779	FLIP STOP PIN	1
328	OR70762	SEE-THRU FRONT GUARD	1	428	OR70780	FLIP STOP	1
329	OR93925	6mm x 28mm SPRING PIN	2	429	OR93370	M6 NYLOK NUT	1
330	OR70763	SPACER	2	501	OR70781	SWITCH ASSY	1
331	OR70764	SEE-THRU SIDE GUARD	2	502	OR70782	SWITCH BRACKET	1
332	OR70765	GUARD LINK	4	503	OR91777	M5 x 15mm PAN HEAD SCREW	2
333	OR92720	M5 x 12mm FLAT HEAD SCREW	4	504	OR90145	M5 LOCK WASHER	2
334	OR90462	M5 FLAT WASHER	8	505	OR90462	M5 FLAT WASHER	2
335	OR93903	M5 NYLOK NUT	8	506	OR93930	M6 x 10mm PAN HEAD SCREW	1
336	OR93931	M5 x 14mm FLAT HEAD SCREW	4	507	OR90502	M6 LOCK WASHER	3
				508	OR90059	M6 FLAT WASHER	3
				509	OR90333	M6 x 10mm HEX HEAD SCREW	2
				510	OR70785	MANUAL (NOT SHOWN)	1
				511	OR70786	MANUAL FRENCH (NOT SHOWN)	1
				512	OR70787	MANUAL SPANISH (NOT SHOWN)	1
				513	OR71407	SWITCH LOCKOUT	1
				514	OR90462	M5 FLAT WASHER	2
				515	OR90145	M5 LOCK WASHER	2
				516	OR90507	M5 x 8mm PAN HEAD SCREW	2

**NOTE: 2** Current model REF 261 has a threaded hole for REF. 308. Requires REF. 301  
Early model REF. 261A has a clearance hole for REF. 308A. Requires REF. 301A; 309A.

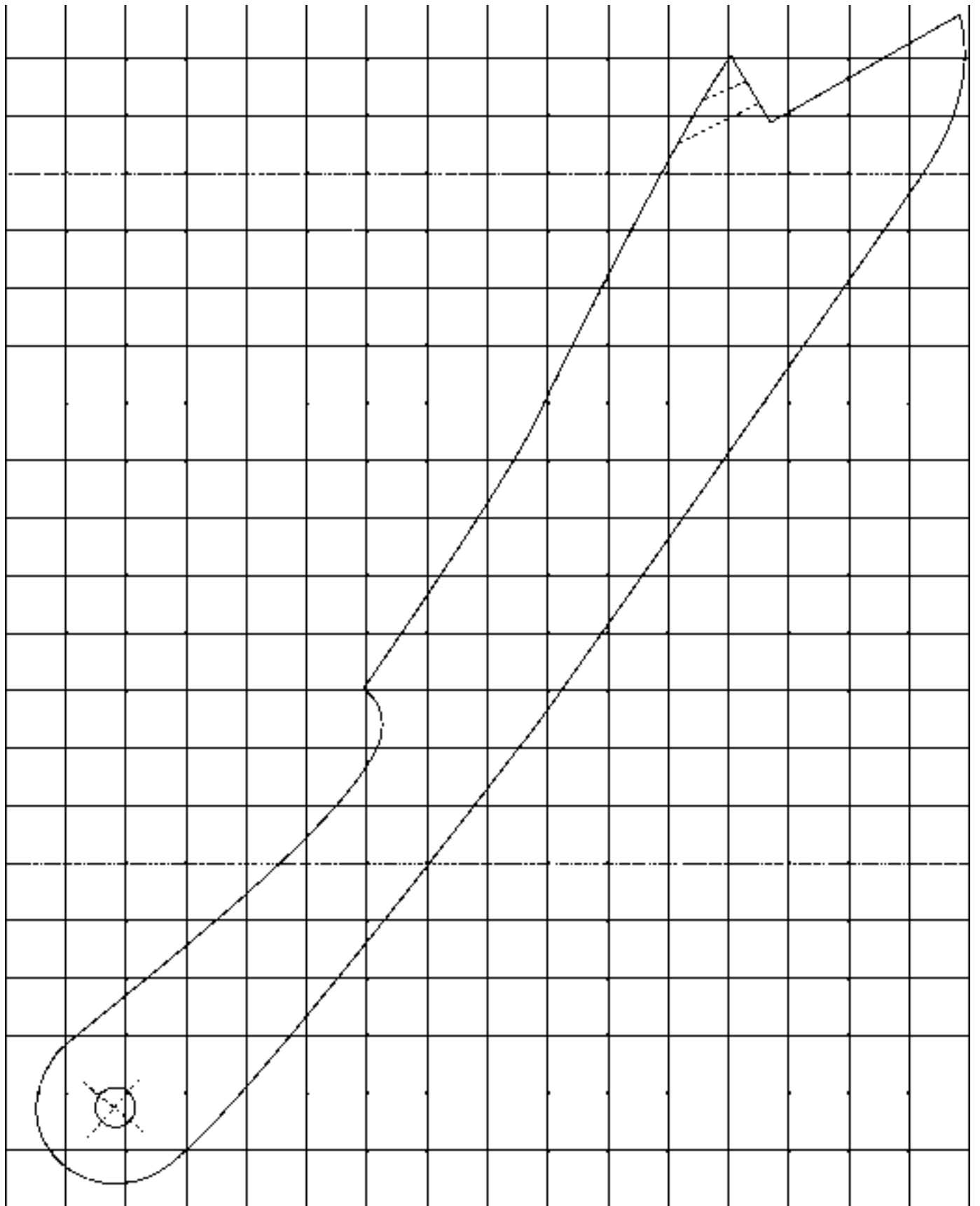

# ◆ NOTES ◆

# ◆ NOTES ◆



# **STEEL CITY TOOL WORKS**

**[www.steelcitytoolworks.com](http://www.steelcitytoolworks.com)**

**1-877-SC4-TOOL**

**(1-877-724-8665)**

---

*5 Year Warranty*

