

User Manual

Read and understand this manual before using machine.

12" TABLE SAW

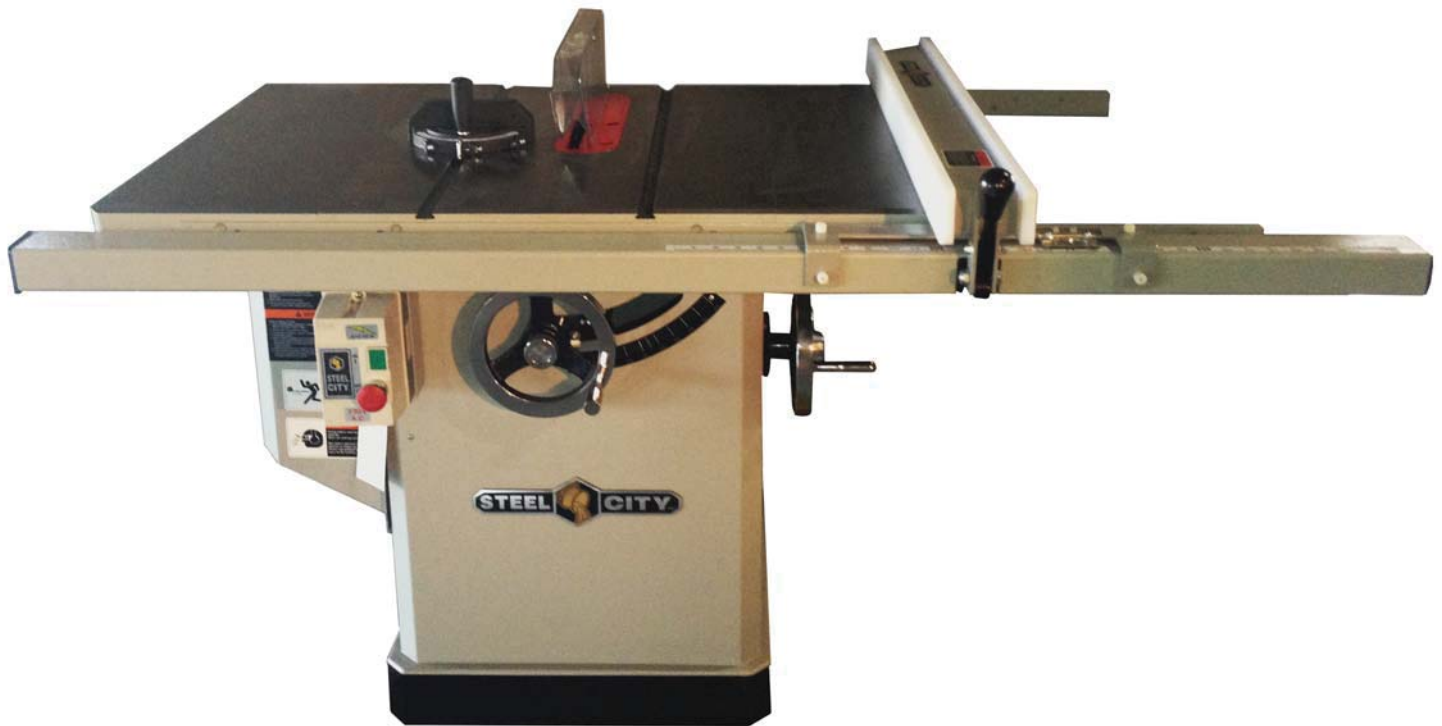

STEEL CITY TOOL WORKS
VER. 10.13

Model Number
35637P30

Manual Part No. OR70655

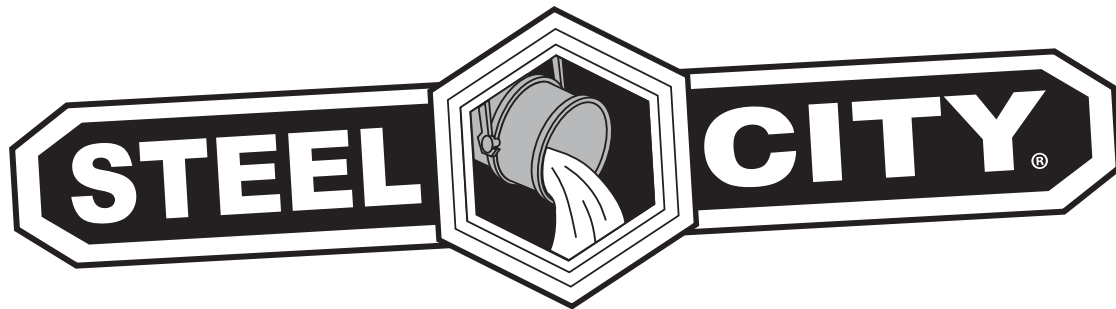

THANK YOU for purchasing your new Steel City Table Saw. This table saw has been designed, tested, and inspected with you, the customer, in mind. When properly assembled, used and maintained, your table saw will provide you with years of trouble free service, which is why it is backed by one of the longest machinery warranties in the business.

This table saw is just one of many products in the Steel City's family of woodworking machinery and is proof of our commitment to total customer satisfaction.

At Steel City we continue to strive for excellence each and every day and value the opinion of you, our customer. For comments about your table saw or Steel City Tool Works, please visit our web site at www.steelcitytoolworks.com .

TABLE OF CONTENTS

INTRODUCTION

SECTION 1	Warranty	4
SECTION 2	Product Specifications	7
SECTION 3	Accessories and Attachments	7
SECTION 4	Definition of Terms	8
SECTION 5	Feature Identification	9
SECTION 6	General Safety	10
SECTION 7	Product Safety	12
SECTION 8	Electrical Requirements.....	14-15
SECTION 9	Unpacking & Inventory.....	17
SECTION 10	Assembly	19
SECTION 11	Adjustments	21
SECTION 12	Operations	25
SECTION 13	Maintenance	29
SECTION 14	Troubleshooting	30
SECTION 15	Parts List.....	32-37

INTRODUCTION

This user manual is intended for use by anyone working with this machine. It should be kept available for immediate reference so that all operations can be performed with maximum efficiency and safety. Do not attempt to perform maintenance or operate this machine until you have read and understand the information contained in this manual.

The drawings, illustrations, photographs, and specifications in this user manual represent your machine at time of print. However, changes may be made to your machine or this manual at any time with no obligation to Steel City Tool Works.

WARRANTY

1 YEAR LIMITED WARRANTY

Steel City Tool Works, LLC (SCTW) warrants this SCTW machinery to be free of defects in workmanship and materials for a period of 1 years from the date of the original retail purchase by the original owner for domestic use. Granite components are warranted for 1 years based on normal use and is void if non SCTW accessories are used that cause the break or chip. Customer must advise SCTW within 30 days for any damage or defect found upon receipt of the product to qualify for the warranty on granite.

The warranty does not cover any product used for professional or commercial production purpose nor for industrial or educational applications. Such cases are covered by our 1 year Limited Warranty with the Conditions and Exceptions listed below.

Conditions and exception:

Warranty applies to the original buyer only and may not be transferred. Original proof of purchase is required.

Warranty does not include failures, breakage or defects deemed after inspection by an Authorized Service Center, (ASC) or agent of, have been directly or indirectly caused by or resulting from improper use, lack of or improper maintenance, misuse or abuse, negligence, accidents, damage in handling or transport, or normal wear and tear of any part or component.

Additionally, warranty is void if repairs or alterations are made to the machine by an unauthorized service center without the direct consent of SCTW

Consumables such as blades, knives, bits and sandpaper are not covered.

Wear items such as drive belt, bearings, switch, are covered for 1 year.

To file a claim of warranty or to find a service center, call toll free 877-724-8665 or email customercare@steelcitytoolworks.net and you must be able to present the original or photo copy of the sales receipt including the serial number from the machine and/or carton.

SCTW will inspect, repair or replace, at its expense and its option, any part that has proven to be defective in workmanship or material, provided that the customer returns the product prepaid to a designated ASC and provides SCTW with a reasonable opportunity to verify the alleged defect by inspection. SCTW will return the product or replacement at our expense unless it is determined by us that there is no defect or that the defect resulted from causes not within the scope of our *warranty in which case we will, at your direction, dispose of or return the product.* In the event you choose to have the product returned, you will be responsible for the handling and shipping costs of the return.

SCTW furnishes the above warranties in lieu of all other warranties, express or implied. SCTW shall not be liable for any special, indirect, incidental, punitive or consequential damages, including without limitation loss of profits arising from or related to the warranty, the breach of any agreement or warranty, or the operation or use of its machinery, including without limitation damages arising from damage to fixtures, tools, equipment, parts or materials, direct or indirect loss caused by and other part, loss of revenue or profits, financing or interest charges, and claims by and third person, whether or not notice of such possible damages has been given to SCTW. Damages or any kind for any delay by or failure of SCTW to perform its obligations under this agreement or claims made a subject of a legal proceeding against SCTW more than one (1) year after such cause of action first arose.

The validity, construction and performance of this Warranty and any sale of machinery by SCTW shall be governed by the law of the Commonwealth of Pennsylvania, without regard to conflicts of law's provisions of any jurisdiction. Any action related in any way to any alleged or actual offer, acceptance or sale by SCTW or any claim related to the performance of and agreement including without limitation this Warranty, shall take place in the federal or state courts in Allegheny County, Pennsylvania.

Warranty registration card must be submitted to SCTW for purpose of proof within 90 days of purchase with a copy of the sales receipt. Failure to do so will, revert the 1 year warranty to 1/2 year as in the terms stated above. This registration is also ~~needed~~ to facilitate contact in case of a safety recall.

This warranty gives you specific legal rights and you may have other rights which vary in certain States or Provinces.

Note to user

This instruction manual is meant to serve as a guide only. Specification and references are subject to change without prior notice. Check the website www.steelcitytoolworks.com for updated manuals with reference to the VER# located on the front page.

LIMITED WARRANTY

The warranty does not cover any product used for professional or commercial production purpose nor for industrial or educational applications. Such cases are covered by our 30 days Limited Warranty with the Conditions and Exceptions listed previously.

WARRANTY CARD

Name _____
 Street _____
 Apt. No. _____
 City _____ State _____ Zip _____
 Phone Number _____
 E-Mail _____

Product Description: _____
 Model No.: _____
 Serial No. _____

The following information is given on a voluntary basis and is strictly confidential.

1. Where did you purchase your STEEL CITY machine?
 Store: _____
 City: _____

2. How did you first learn of Steel City Tool Works?
 Advertisement Mail Order Catalog
 Web Site Friend
 Local Store Other _____

3. Which of the following magazines do you subscribe to?
 American Woodworker American How-To
 Cabinetmaker Family Handyman
 Fine Homebuilding Fine Woodworking
 Journal of Light Construction Old House Journal
 Popular Mechanics Popular Science
 Popular Woodworking Today's Homeowner
 WOOD Woodcraft
 WOODEN Boat Woodshop News
 Woodsmith Woodwork
 Woodworker Woodworker's Journal
 Workbench Other _____

4. Which of the following woodworking / remodeling shows do you watch?
 Backyard America The American Woodworker
 Home Time The New Yankee Workshop
 This Old House Woodwright's Shop
 Other _____

5. What is your annual household income?
 \$20,000 to \$29,999 \$30,000 to \$39,999
 \$40,000 to \$49,999 \$50,000 to \$59,999
 \$60,000 to \$69,999 70,000 to \$79,999
 \$80,000 to \$89,999 \$90,000 +

6. What is your age group?
 20 to 29 years 30 to 39 years
 40 to 49 years 50 to 59 years
 60 to 69 years 70 + years

7. How long have you been a woodworker?
 0 to 2 years 2 to 8 years
 8 to 20 years over 20 years

8. How would you rank your woodworking skills?
 Simple Intermediate
 Advance Master Craftsman

9. How many Steel City machines do you own? _____

10. What stationary woodworking tools do you own?
Check all that apply.
 Air Compressor Band Saw
 Drill Press Drum Sander
 Dust Collection Horizontal Boring Machine
 Jointer Lathe
 Mortiser Panel Saw
 Planer Power Feeder
 Radial Arm Saw Shaper
 Spindle Sander Table Saw
 Vacuum Veneer Press Wide Belt Sander
 Other _____

11. Which benchtop tools do you own? *Check all that apply.*
 Belt Sander Belt / Disc Sander
 Drill Press Band Saw
 Grinder Mini Jointer
 Mini Lathe Scroll Saw
 Spindle / Belt Sander Other _____

12. Which portable / hand held power tools do you own?
Check all that apply.
 Belt Sander Biscuit Jointer
 Dust Collector Circular Saw
 Detail Sander Drill / Driver
 Miter Saw Orbital Sander
 Palm Sander Portable Thickness Planer
 Saber Saw Reciprocating Saw
 Router Other _____

13. What machines / accessories would you like to see added to the STEEL CITY line?

14. What new accessories would you like to see added?

15. Do you think your purchase represents good value?
 Yes No

16. Would you recommend STEEL CITY products to a friend?
 Yes No

17. Comments:

CUT HERE

FOLD ON DOTTED LINE

PLACE
STAMP
HERE

SteelCityToolWorks
#4 Northpoint Court
Bolingbrook, IL 60440

FOLD ON DOTTED LINE

PRODUCT SPECIFICATIONS

Blade Diameter	12"
Arbor Diameter	1"
Maximum Depth of Cut	4"
Maximum Thickness at 45 cut	2-7/8"
Table in front of Saw	12"
Maximum Width of Dado	13/16"
Maximum Diameter of Dado	10"
Dust Port Diameter	4"
Table Height	33-7/8"
Table Size(with extension)	29" D x 44" W
Table Size(without extension)	29" D x 22" W
Blade Speed	4200

Motor

Type	Induction
HorsePower	7.5 HP
Amps	18
Voltage	230 V
Phase	Three
Hertz	60
RPM	3450

Product Dimensions

Footprint	22-1/4" X 22-1/4"
Length	44-1/2"
Width	35"
Height	40"
Weight	400 lbs.

Shipping Dimensions

Carton Type	Box on Pallet
Length	32"
Width	34"
Height	41"
Gross Weight	430 lbs.

Saw Components

Saw Body	35635
Rail	35674
Fence Body	35673

ACCESSORIES AND ATTACHMENTS

There are a variety of accessories available for your Steel City Product. For more information on any accessories associated with this and other machines, please contact your nearest Steel City distributor, or visit our website at: www.steelcitytoolworks.com.

DEFINITION OF TERMS

Anti-Kickback Fingers – A safety device attached to the blade guard and splitter assembly designed to minimize the chance of a workpiece being thrown back during a cutting operation.

Arbor – The shaft on which the blade or accessory cutting-tool is mounted.

Bevel Cut – The operation of making any cut with the blade set at an angle other than 90 degrees.

Compound Cut – The operation of making both a bevel and a miter cut at one time.

Crosscut – The operation of making a cut across the grain or width of a workpiece.

Dado – A non-through cut that produces a square notch. A dado is typically from 1/8-in. to 13/16-in. wide. A dado requires a special set of blades, not included with this table saw.

Featherboard – An accessory device that can be made or purchased to help guide or hold down a workpiece during cutting operations.

Freehand – A very dangerous operation of making a cut without using the fence or miter gauge in a cutting operation. Freehand cuts must never be performed on a Table Saw.

Gum, Pitch or Resin – A sticky, sap based residue that comes from wood products.

Heeling – The misalignment of the blade to the miter slots; when the blade is not parallel to the miter slots.

Kerf – The material removed from the workpiece by the blade during any cutting operation.

Kickback – When the workpiece is thrown back toward the operator at a high rate of speed during a cutting operation.

Miter Cut – The operation of making a cut using the miter gauge at any angle other than zero degrees.

Push Stick – An accessory device that can be made or purchased to help push the workpiece through the blade. A push stick is used to keep the operator's hands away from the blade when ripping a narrow workpiece.

Rabbet – A square notch in the edge of the workpiece.

Rip Cut – The operation of making a cut with the grain or down the length of the workpiece.

Saw Blade Path – The area that is directly in line with the blade, including area over, under, behind and in front of it.

Set of the Saw Blade – The distance that the tips of the saw blade are angled outwards from the thickness of the blade. The set of the saw blade teeth allows for the blade body to pass safely through all cuts.

Table/Work Area – The total surface of the top of the table saw on which the workpiece rests while set-up or cutting operations are being performed.

FEATURE IDENTIFICATION

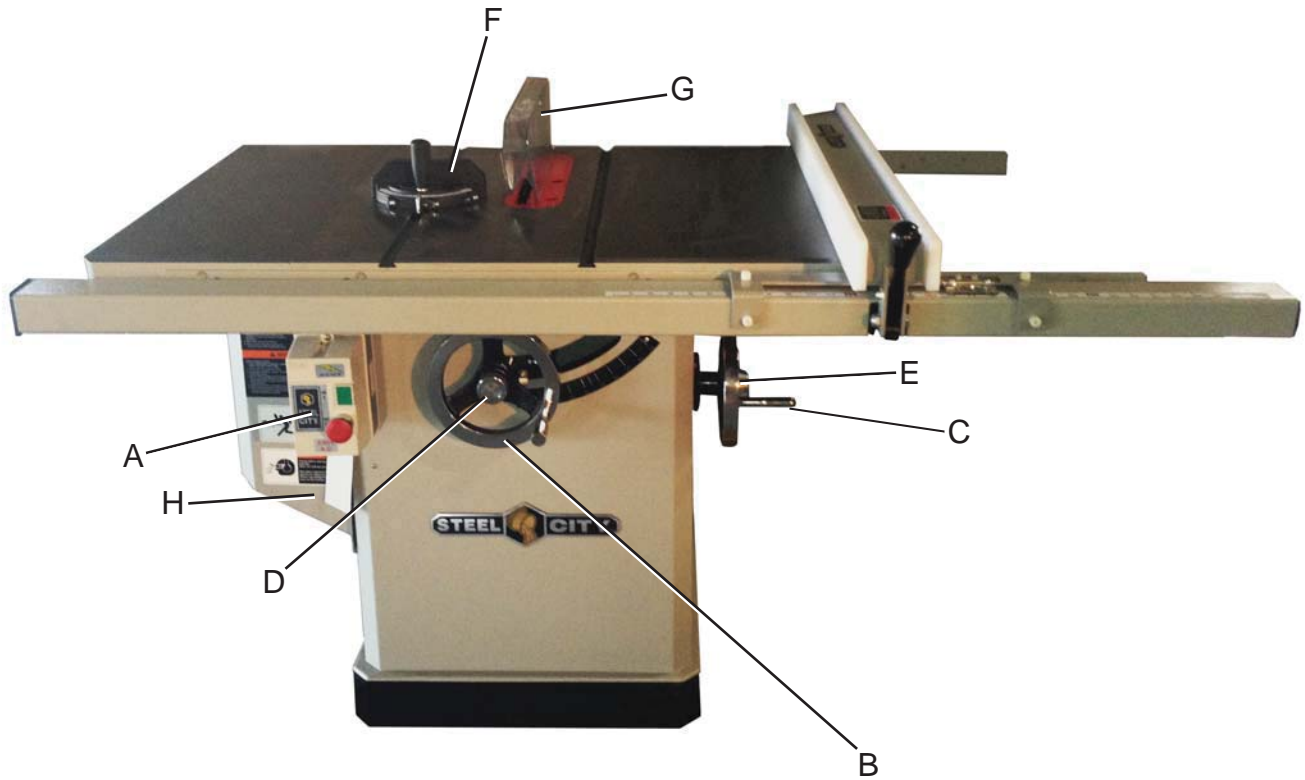

- A) Switch
- B) Blade Height Adjustment Handwheel
- C) Bevel Adjustment Handwheel
- D) Blade Height Lock Knob
- E) Bevel Lock Knob
- F) Miter Gauge
- G) Blade Guard Assembly
- H) Motor Cover

GENERAL SAFETY

⚠ WARNING

TO AVOID serious injury and damage to the machine, read and follow all Safety and Operating Instructions before assembling and operating this machine.

This manual is not totally comprehensive. It does not and can not convey every possible safety and operational problem which may arise while using this machine. The manual will cover many of the basic and specific safety procedures needed in an industrial environment.

All federal and state laws and any regulations having jurisdiction covering the safety requirements for use of this machine take precedence over the statements in this manual. Users of this machine must adhere to all such regulations.

Below is a list of symbols that are used to attract your attention to possible dangerous conditions.



This is the international safety alert symbol. It is used to alert you to potential personal injury hazards. Obey all safety messages that follow this symbol to avoid possible injury or death.

⚠ DANGER

Indicates an imminently hazardous situation which, if not avoided, **WILL** result in death or serious injury.

⚠ WARNING

Indicates a potentially hazardous situation which, if not avoided, **COULD** result in death or serious injury.

⚠ CAUTION

Indicates a potentially hazardous situation, if not avoided, **MAY** result in minor or moderate injury. It may also be used to alert against unsafe practices.

CAUTION

CAUTION used without the safety alert symbol indicates a potentially hazardous situation which, if not avoided, may result in property damage.

NOTICE

This symbol is used to alert the user to useful information about proper operation of the machine.

⚠ WARNING

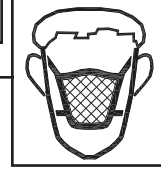

Exposure to the dust created by power sanding, sawing, grinding, drilling and other construction activities may cause serious and permanent respiratory or other injury, including silicosis (a serious lung disease), cancer, and death. Avoid breathing the dust, and avoid prolonged contact with dust. The dust may contain chemicals known to the State of California to cause cancer, birth defects or other reproductive harm.

Some examples of these chemicals are:

- Lead from lead-based paints.
- Crystalline silica from bricks, cement and other masonry products.
- Arsenic and chromium from chemically-treated lumber.

Always operate tool in well ventilated area and provide for proper dust removal. Use a dust collection system along with an air filtration system whenever possible. Always use properly fitting NIOSH/OSHA approved respiratory protection appropriate for the dust exposure, and wash exposed areas with soap and water.

1. To avoid serious injury and damage to the machine, read the entire User Manual before assembly and operation of this machine.

⚠ WARNING

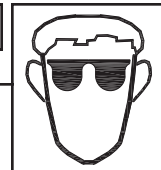

2. **ALWAYS** wear eye protection. Any machine can throw debris into the eyes during operations, which could cause severe and permanent eye damage. Everyday eyeglasses are **NOT** safety glasses. **ALWAYS** wear Safety Goggles (that comply with ANSI standard Z87.1) when operating power tools.

▲ WARNING

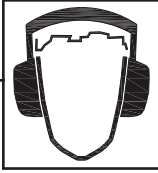

3. **ALWAYS** wear hearing protection. Plain cotton is not an acceptable protective device. Hearing equipment should comply with ANSI S3.19 Standards.

▲ WARNING

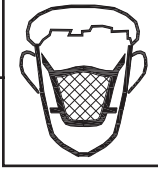

4. **ALWAYS** wear a NIOSH/OSHA approved dust mask to prevent inhaling dangerous dust or airborne particles.

5. **ALWAYS** keep the work area clean, well lit, and organized. **DO NOT** work in an area that has slippery floor surfaces from debris, grease, and wax.
6. **ALWAYS** unplug the machine from the electrical receptacle before making adjustments, changing parts or performing any maintenance.
7. **AVOID ACCIDENTAL STARTING.** Make sure that the power switch is in the "OFF" position before plugging in the power cord to the electrical receptacle.

▲ WARNING

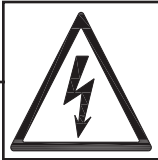

8. **AVOID** a dangerous working environment. **DO NOT** use electrical tools in a damp environment or expose them to rain or moisture.

▲ WARNING



9. **CHILDPROOF THE WORKSHOP AREA** by removing switch keys, unplugging tools from the electrical receptacles, and using padlocks.

10. **DO NOT** use electrical tools in the presence of flammable liquids or gasses.

11. **DO NOT FORCE** the machine to perform an operation for which it was not designed. It will do a safer and higher quality job by only performing operations for which the machine was intended.
12. **DO NOT** stand on a machine. Serious injury could result if it tips over or you accidentally contact any moving part.
13. **DO NOT** store anything above or near the machine.
14. **DO NOT** operate any machine or tool if under the influence of drugs, alcohol, or medication.
15. **EACH AND EVERY** time, check for damaged parts prior to using any machine. Carefully check all guards to see that they operate properly, are not damaged, and perform their intended functions. Check for alignment, binding or breakage of all moving parts. Any guard or other part that is damaged should be immediately repaired or replaced.
16. Ground all machines. If any machine is supplied with a 3-prong plug, it must be plugged into a 3-contact electrical receptacle. The third prong is used to ground the tool and provide protection against accidental electric shock. **DO NOT** remove the third prong.
17. Keep visitors and children away from any machine. **DO NOT** permit people to be in the immediate work area, especially when the machine is operating.
18. **KEEP** protective guards in place and in working order.
19. **MAINTAIN** your balance. **DO NOT** extend yourself over the tool. Wear oil resistant rubber soled shoes. Keep floor clear of debris, grease, and wax.
20. **MAINTAIN** all machines with care. **ALWAYS KEEP** machine clean and in good working order. **KEEP** all blades and tool bits sharp.
21. **NEVER** leave a machine running, unattended. Turn the power switch to the OFF position. **DO NOT** leave the machine until it has come to a complete stop.
22. **REMOVE ALL MAINTENANCE TOOLS** from the immediate area prior to turning the machine ON.
23. **SECURE** all work. When it is possible, use clamps or jigs to secure the workpiece. This is safer than attempting to hold the workpiece with your hands.
24. **STAY ALERT**, watch what you are doing, and use common sense when operating any machine. **DO NOT** operate any machine tool while tired or under the influence of drugs, alcohol, or medication. A moment of inattention while operating power tools may result in serious personal injury.

25. **USE ONLY** recommended accessories. Use of incorrect or improper accessories could cause serious injury to the operator and cause damage to the machine. If in doubt, **DO NOT** use it.
26. **THE USE** of extension cords is not recommended for 230V equipment. It is better to arrange the placement of your equipment and the installed wiring to eliminate the need for an extension cord. If an extension cord is necessary, refer to the chart in the Grounding Instructions section to determine the minimum gauge for the extension cord. The extension cord must also contain a ground wire and plug pin.
27. Wear proper clothing, **DO NOT** wear loose clothing, gloves, neckties, or jewelry. These items can get caught in the machine during operations and pull the operator into the moving parts. Users must wear a protective cover on their hair, if the hair is long, to prevent it from contacting any moving parts.
28. **SAVE** these instructions and refer to them frequently and use them to instruct other users.
29. Information regarding the safe and proper operation of this tool is also available from the following sources:
 - Power Tool Institute
1300 Summer Avenue
Cleveland, OH 44115-2851
www.powertoolinstitute.org
 - National Safety Council
1121 Spring Lake Drive
Itasca, IL 60143-3201
 - American National Standards Institute
25West 43rd. St, 4th Floor
New York, NY. 10036
ANSI 01.1 Safety Requirements
For Woodworking Machines
WWW.ANSI.ORG
 - U.S. Department of Labor Regulations
OSHA 1910.213 Regulations
WWW.OSHA.GOV

PRODUCT SAFETY

1. Serious personal injury may occur if normal safety precautions are overlooked or ignored. Accidents are frequently caused by lack of familiarity or failure to pay attention. Obtain advice from supervisor, instructor, or another qualified individual who is familiar with this machine and its operations.
2. Every work area is different. Always consider safety first, as it applies to your work area. Use this machine with respect and caution. Failure to do so could result in serious personal injury and damage to the machine.
3. Prevent electrical shock. Follow all electrical and safety codes, including the National Electrical Code (NEC) and the Occupational Safety and Health Regulations (OSHA). All electrical connections and wiring should be made by qualified personnel only.
6. Safety decals are on this machine to warn and direct you to how to protect yourself or visitors from personal injury. These decals **MUST** be maintained so that they are legible. **REPLACE** decals that are not legible.
7. **DO NOT** leave the unit plugged into the electrical outlet. Unplug the unit from the outlet when not in use and before servicing, performing maintenance tasks, or cleaning.
8. **ALWAYS** turn the power switch "OFF" before unplugging the table saw.



4. **TO REDUCE** the risk of electrical shock. **DO NOT** use this machine outdoors. **DO NOT** expose to rain or moisture. Store indoors in a dry area.

5. **STOP** using this machine, if at any time you experience difficulties in performing any operation. Contact your supervisor, instructor or machine service center immediately.

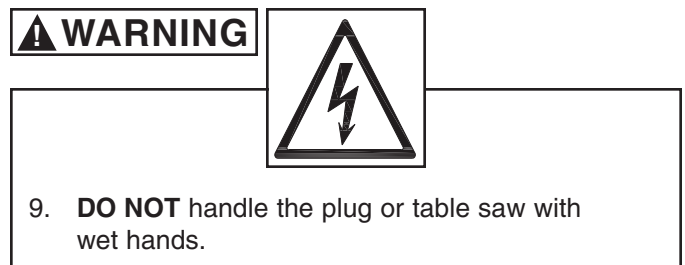

9. **DO NOT** handle the plug or table saw with wet hands.

10. **USE** accessories only recommended by Steel City.
11. **DO NOT** pull the table saw by the power cord. **NEVER** allow the power cord to come in contact with sharp edges, hot surfaces, oil or grease.
12. **DO NOT** unplug the table saw by pulling on the power cord. **ALWAYS** grasp the plug, not the cord.

13. **REPLACE** a damaged cord immediately. **DO NOT** use a damaged cord or plug. **DO NOT** use if the table saw is not operating properly, or has been damaged, left outdoors or has been in contact with water.
14. **DO NOT** use the table saw as a toy. **DO NOT** use near or around children.
15. **ENSURE** that the machine sits firmly on the floor before using. If the machine wobbles or is unstable, correct the problem by using shims or blocks prior to operation.
16. **KEEP** saw blade sharp and clean. Failure to do so greatly increases friction, decreases cut quality, and increases the possibility of a kickback
17. **MAKE CERTAIN** the saw blade is parallel with the miter slots and with the rip fence. A blade that is not aligned parallel can cause the workpiece to be pinched between the blade and the fence causing burning or kickbacks.
18. **ALWAYS** use blade guard on all through cuts. This will help prevent the cut from closing on the back of the saw blade. The blade guard also has anti-kickback fingers which minimize the chance of a workpiece being thrown back during a cutting operation.
19. **ALWAYS** push the workpiece past the blade. **DO NOT** release a workpiece until it is past the blade and removed from the saw.
20. **DO NOT** execute a cut when you do not have complete control of the situation.
21. **DO NOT** cut a workpiece that is too large for you to safely handle. Use an outfeed table or workstand to properly support the piece.
22. **DO NOT** use the rip fence as a guide when cross-cutting
23. **BE MINDFUL** of flaws in the wood. Cutting a warped or twisted board along the rip fence can get pinched between the fence and the blade, causing a kickback
24. **ALWAYS** remove cut off pieces and scraps from the table before starting the saw
25. **NEVER** start the machine with the workpiece against the blade
26. **NEVER** perform freehand operations. Use either the fence or miter gauge to position and guide the workpiece through the blade.
27. **ALWAYS** use a pushstick for ripping narrow workpieces
28. **NEVER** have any part of your body in line with the path of the saw blade. If a kickback occurs with you directly in front of the blade, a serious injury can occur.
29. **NEVER** attempt to free a stalled blade without first turning the machine off and disconnecting the saw from the power source.
30. **DO NOT** reach over or behind a rotating saw blade.

ELECTRICAL REQUIREMENTS

USE THIS SETUP FOR MODEL NUMBER 35636 ONLY

TO PREVENT electrical shock, follow all electrical and safety codes, including the National Electrical Code (NEC) and the Occupational Safety and Health Regulations (OSHA). All electrical connections and wiring should be made by qualified personnel only.

TO REDUCE the risk of electrical shock, **DO NOT** use machine outdoors. **DO NOT** expose to rain or moisture. Store indoors in a dry area.

DO NOT connect the machine to the power source before you have completed the set up process.

DO NOT connect the machine to the power source until instructed to do so.

This motor in this machine is designed to run at 230V. Power connections must be made at the switch. For connections, refer to wiring photo Fig. A.

On your incoming power line:

1. The White Lead connects to terminal L1.
2. The Black Lead connects to terminal L3.
3. The Ground Wire connects to the grounding terminal.

Notice: Some Table Saws will be equipped with a junction box located near the base of the saw. If this is the case with your model saw, all power connections will be made in the junction box instead of at the switch. The junction box will have markings for L1, L3, and Ground. Following the steps above, connect the wires to their proper terminals.

Fig. A

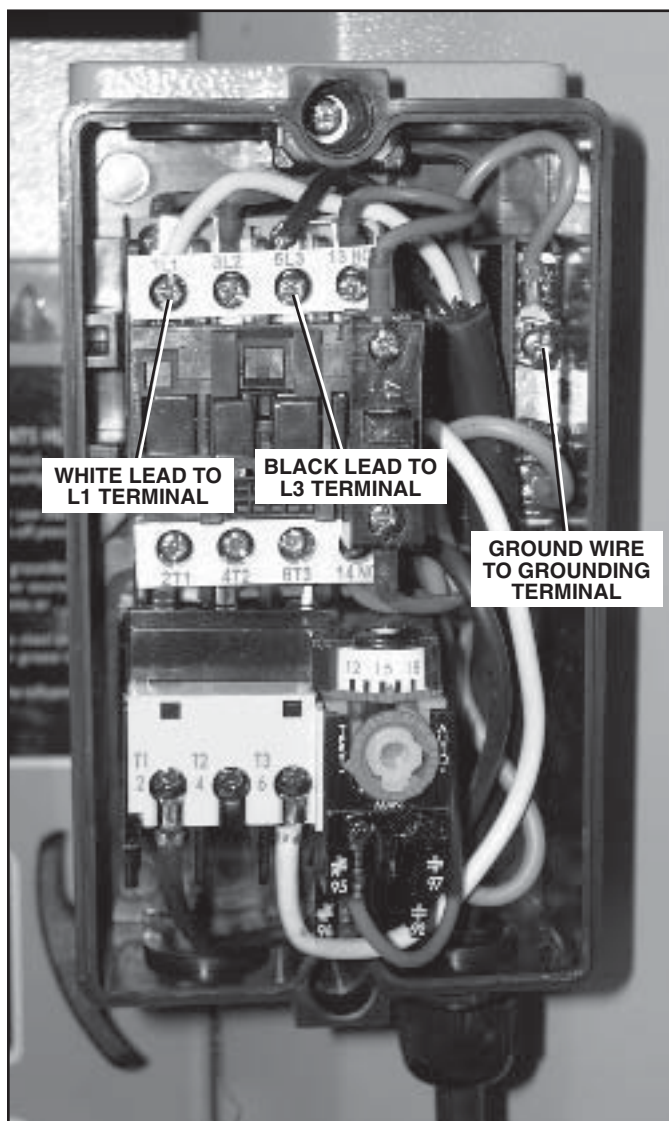

ELECTRICAL REQUIREMENTS

USE THIS SETUP FOR MODEL NUMBER 35635 ONLY

TO PREVENT electrical shock, follow all electrical and safety codes, including the National Electrical Code (NEC) and the Occupational Safety and Health Regulations (OSHA). All electrical connections and wiring should be made by qualified personnel only.

TO REDUCE the risk of electrical shock, **DO NOT** use machine outdoors. **DO NOT** expose to rain or moisture. Store indoors in a dry area.

DO NOT connect the machine to the power source before you have completed the set up process.

DO NOT connect the machine to the power source until instructed to do so.

The motor in this machine is designed for 230 Volt 3 phase use. Power connections for this must be made at the switch. For connections refer to wiring photo Fig. B.

On your incoming power line:

1. The White Lead connects to terminal L1
2. The Black Lead connects to terminal L2
3. The Red Lead connects to terminal L3
4. The Ground Line connects to the grounding terminal

After making these connections, turn the saw on to make sure that the arbor is turning towards the operator. If the arbor rotates in the proper direction the connection is complete. If the arbor rotates away from the operator, switch any 2 lines with one another to change direction of rotation.

Notice: Some Table Saws will be equipped with a junction box located near the base of the saw. If this is the case with your model saw, all power connections will be made in the junction box instead of at the switch. The junction box will have terminals for L1, L2, L3, and Ground. Following the steps above, connect the wires to their proper terminals.

Fig. B

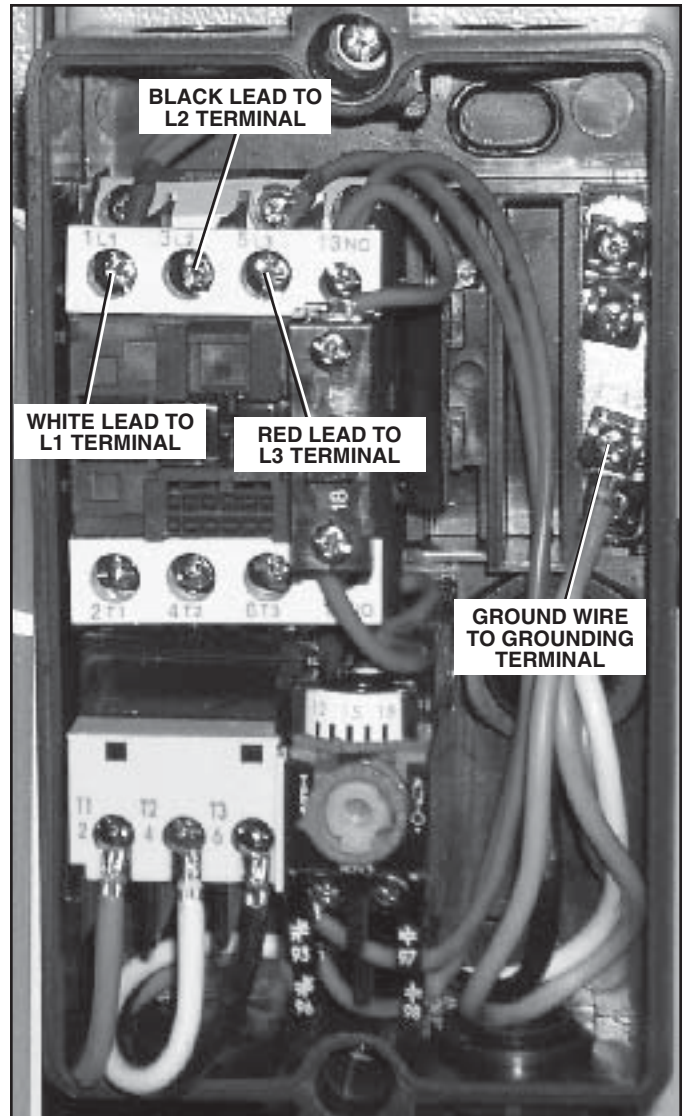

GROUNDING INSTRUCTIONS

⚠ WARNING



This machine **MUST BE GROUNDED** while in use to protect the operator from electric shock.

In the event of a malfunction or breakdown, **GROUNDING** provides the path of least resistance for electric current and reduces the risk of electric shock. The plug **MUST** be plugged into a matching electrical receptacle that is properly installed and grounded in accordance with **ALL** local codes and ordinances.

If a plug is provided with your machine **DO NOT** modify the plug. If it will not fit your electrical receptacle, have a qualified electrician install the proper connections to meet all electrical codes local and state. All connections must also adhere to all of OSHA mandates.

IMPROPER ELECTRICAL CONNECTION of the equipment-grounding conductor can result in risk of electric shock. The conductor with the green insulation (with or without yellow stripes) is the equipment-grounding conductor. **DO NOT** connect the equipment-grounding conductor to a live terminal.

Check with a qualified electrician or service personnel if you do not completely understand the grounding instructions, or if you are not sure the tool is properly grounded.

PLUGS/RECEPTACLES

⚠ WARNING



- Electrocution or fire could result if this machine is not grounded properly or if the electrical configuration does not comply with local and state electrical codes.
- **MAKE CERTAIN** the machine is disconnected from power source before starting any electrical work.
- **MAKE SURE** the circuit breaker does not exceed the rating of the plug and receptacle.

Depending on your model table saw, the motor supplied with your machine is either a 230 volt, single phase motor (Model 35636) or a 230 volt, three phase motor (Model 35635). Never connect the green or ground wire to a live terminal.

A machine with a 230 volt plug should only be connected to an outlet having the same configuration as the plug.

EXTENSION CORDS

⚠ WARNING

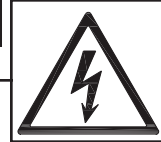

To reduce the risk of fire or electrical shock, use the proper gauge of extension cord. When using an extension cord, be sure to use one heavy enough to carry the current your machine will draw.

The smaller the gauge-number, the larger the diameter of the extension cord is. If in doubt of the proper size of an extension cord, use a shorter and thicker cord. An undersized cord will cause a drop in line voltage resulting in a loss of power and overheating.

⚠ CAUTION

USE ONLY a 3-wire extension cord that has a 3-prong grounding plug and a 3-pole receptacle that accepts the machine's plug.

If you are using an extension cord outdoors, be sure it is marked with the suffix "W-A" ("W" in Canada) to indicate that it is acceptable for outdoor use.

Make certain the extension cord is properly sized, and in good electrical condition. Always replace a worn or damaged extension cord immediately or have it repaired by a qualified person before using it.

Protect your extension cords from sharp objects, excessive heat, and damp or wet areas.

MINIMUM RECOMMENDED GAUGE FOR EXTENSION CORDS (AWG)

230 VOLT OPERATION ONLY			
	25' LONG	50' LONG	100' LONG
0 to 6 Amps	16 AWG	16 AWG	14 AWG
6 to 8 Amps	16 AWG	16 AWG	12 AWG
8 to 12 Amps	14 AWG	14 AWG	10 AWG
12 to 15 Amps	12 AWG	12 AWG	10 AWG
15 to 20 Amps	10 AWG	10 AWG	Not recommended

UNPACKING & INVENTORY

⚠ WARNING

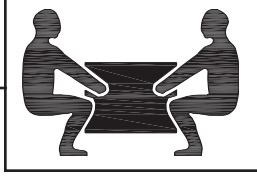

- The machine is heavy, two people are required to unpack and lift.
- Use a safety strap to avoid tip over when lifting machine.

Check shipping carton and machine for damage before unpacking. Carefully remove packaging materials, parts and machine from shipping carton. To remove the carton from the inside of the saw cabinet, crank the handwheel to lower the arbor to its lowest position. Always check for and remove protective shipping materials around motors and moving parts. Lay out all parts on a clean work surface.

Remove any protective materials and coatings from all

of the parts and the table saw. The protective coatings can be removed by spraying WD-40 on them and wiping it off with a soft cloth. This may need redone several times before all of the protective coatings are removed completely.

After cleaning, apply a good quality paste wax to any unpainted surfaces. Make sure to buff out the wax before assembly.

Compare the items to inventory figures; verify that all items are accounted for before discarding the shipping box.

⚠ WARNING

If any parts are missing, do not attempt to plug in the power cord and turn "ON" the machine. The machine should only be turned "ON" after all the parts have been obtained and installed correctly. For missing parts, contact Steel City at 1-877-SC4-TOOL.

- A) Blade Wrenches
- B) Blade Guard Mounting Bracket Assembly
- C) Miter Gauge
- D) Handwheel
- E) Lock Knob
- F) 12mm Wrench

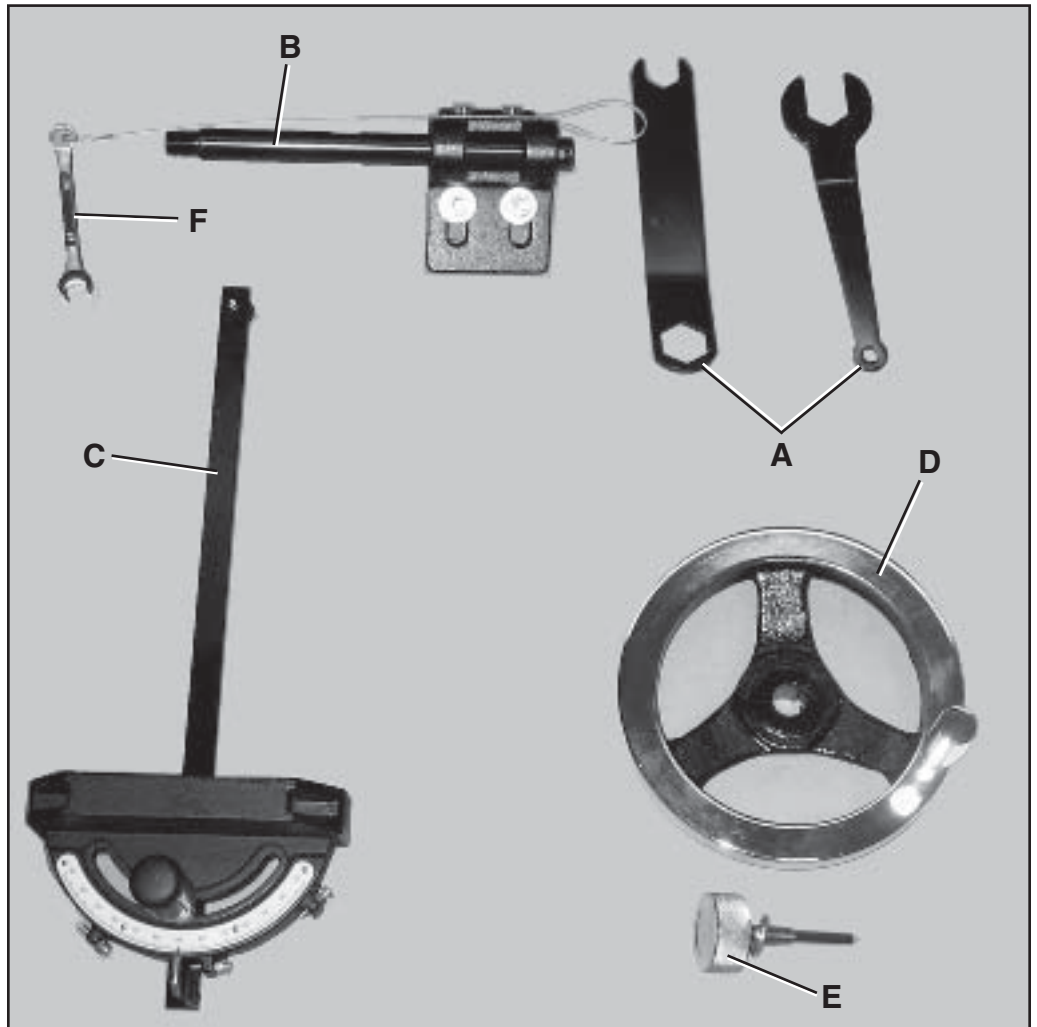

G) Left and Right
Extension Wings

H) Blade Guard
Assembly

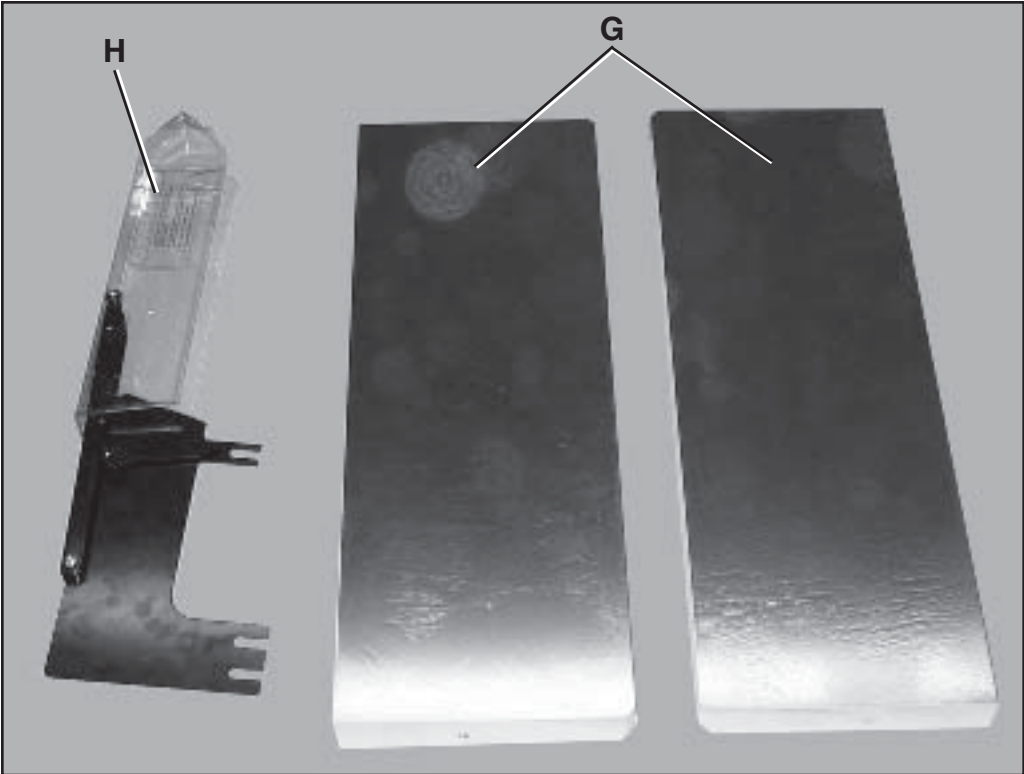

ASSEMBLY

⚠ WARNING

MAKE CERTAIN THAT THE SAW IS DISCONNECTED FROM THE POWER SOURCE.

INSTALLATION AND LEVELING

Final location for the saw must be level, dry, well lighted, and have enough room to allow movement around the saw with long pieces of wood stock.

Level the saw front to back and side to side, using a carpenter's level placed on the table. Use shims under the corners, if necessary, but make sure the saw is stable before being placed into service.

EXTENSION WING ASSEMBLY

1. Attach extension wing to the table with three hex head bolts, three lock washers, and three flat washers. Snug but do not tighten.
2. Slide extension wings toward the front edge of the saw table until two edges are flush. Make certain that the beveled edge of the wing faces towards the front of the saw.

Fig. 2

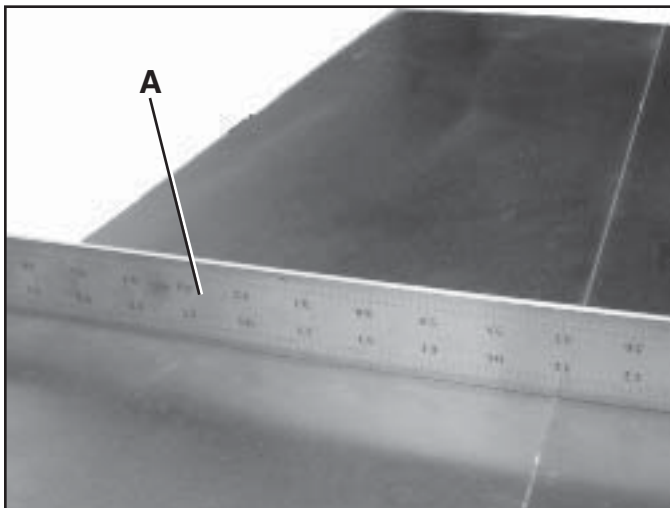

3. Using a straight edge (A), align the extension wings to the saw table and tighten the hex head bolts. **SEE FIG. 2.**
4. Repeat Steps 1-3 for the other wing.

HANDWHEEL ASSEMBLY

Fig. 3



1. Line up the key on the shaft with the keyway in the handwheel (A), and slide the handwheel onto the shaft. **SEE FIG. 3.**
2. Tighten the set screw on the handwheel hub securely to hold in place.
3. Install center lock knob (B) by inserting into center hole in the shaft and threading in a clockwise direction.

Fig. 4

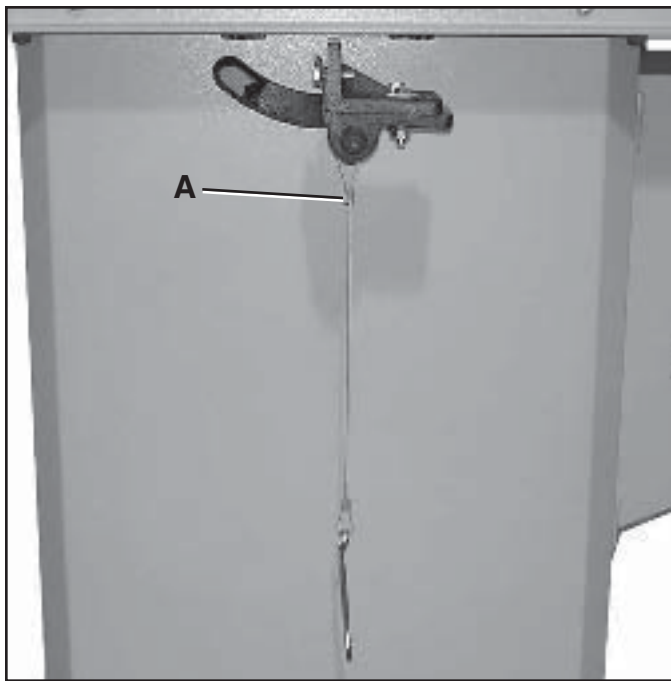

BLADE GUARD ASSEMBLY

⚠ WARNING

MAKE CERTAIN THAT THE SAW IS DISCONNECTED FROM THE POWER SOURCE.

1. Place the closed loop end of the cable (A) with the attached blade guard wrench over the blade guard shaft. **SEE FIG. 4.**
2. Place a lock washer onto the threaded portion of the blade guard shaft.
3. Thread blade guard shaft into rear trunnion through opening at rear of saw.
4. Tighten blade guard shaft. The blade guard post has a flat detent to accommodate wrenches.
5. Place upper and lower bracket assembly in the upright position and snug two set screws just enough to hold in place. Do not tighten firmly at this time.
6. Insert front tab of blade guard splitter through insert opening in the table. Loosen the hex head screw (A) already installed at the factory and insert the front tab of the blade guard splitter. The tab is held in place between the flat washer and bracket. Finger tighten only at this time. **SEE FIG. 5.**
7. Attach rear tab of blade guard splitter to the upper blade guard bracket with two hex head bolts (B). Finger tighten only at this time.
8. A blade will need to be installed before final adjustment can be made.

Fig. 5

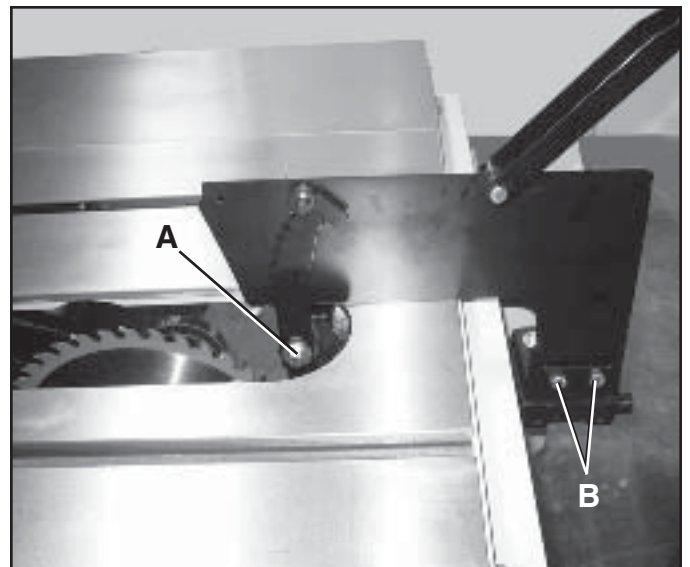

INSTALLING BLADE

⚠ WARNING

MAKE CERTAIN THAT THE SAW IS DISCONNECTED FROM THE POWER SOURCE.

1. Raise the blade arbor fully, set the bevel angle at zero, and lock the arbor by tightening the lock knob in the middle of the handwheel.
2. Remove the arbor nut and flange.
3. Place the blade on the arbor shaft, making sure the teeth point down at the front of the saw. Replace the flange (A) and the arbor nut (B). **SEE FIG. 6.**
4. Using the wrenches provided, securely tighten the arbor nut. Remove the wrenches.

Fig. 6

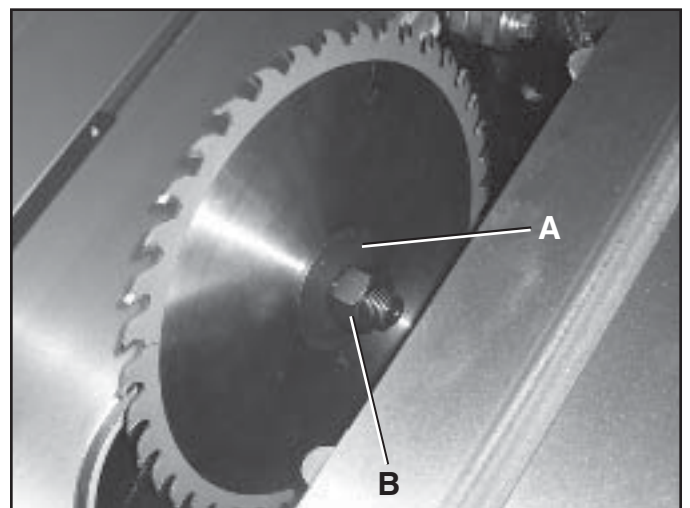

ADJUSTMENTS

ALIGNING BLADE GUARD AND SPLITTER

⚠ WARNING

MAKE CERTAIN THAT THE SAW IS DISCONNECTED FROM THE POWER SOURCE.

Fig. 7

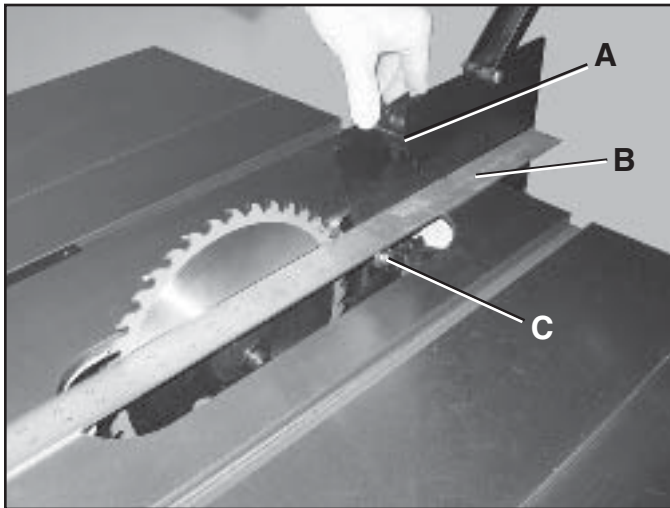

1. Raise blade guard away from table and hold anti-kickback fingers (A) away from table surface. **SEE FIG. 7.**
2. Using an accurate straight edge (B), align the splitter with the saw blade. Be sure the straight edge rests against body of saw blade and not saw teeth.
3. When saw blade is aligned with the splitter, carefully tighten the hex cap bolt (C) on the bracket assembly inside the saw.
4. Make sure the splitter is level with the table and approximately 1/8" above the table before tightening the hardware on the rear of the blade guard assembly. This space between the splitter and the table keeps the splitter from binding on the table when the blade is tilted to 45°.
5. When saw blade is aligned with the splitter, lower the blade, and tighten all hardware.
6. Check alignment again after tightening hardware. Adjust if necessary.

TABLE INSERT ADJUSTMENT

⚠ WARNING

MAKE CERTAIN THAT THE SAW IS DISCONNECTED FROM THE POWER SOURCE.

Fig. 8

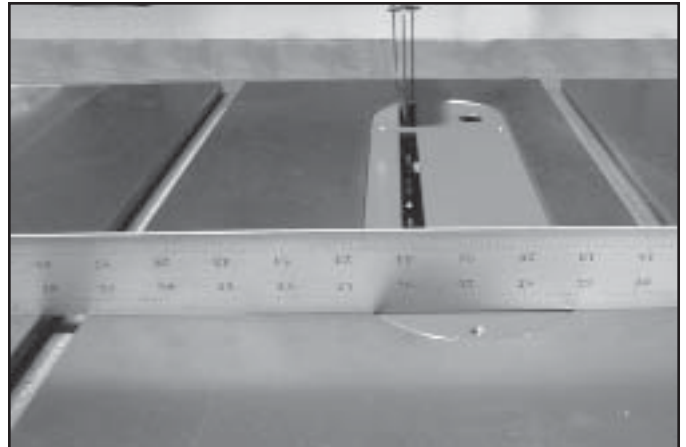

1. Lower blade completely.
2. Place the open end of the insert under the splitter and lower the insert into the opening.
3. Adjust the table insert flush with the table by turning four leveling screws and using a straight edge. **SEE FIG. 8.**

Fig. 9

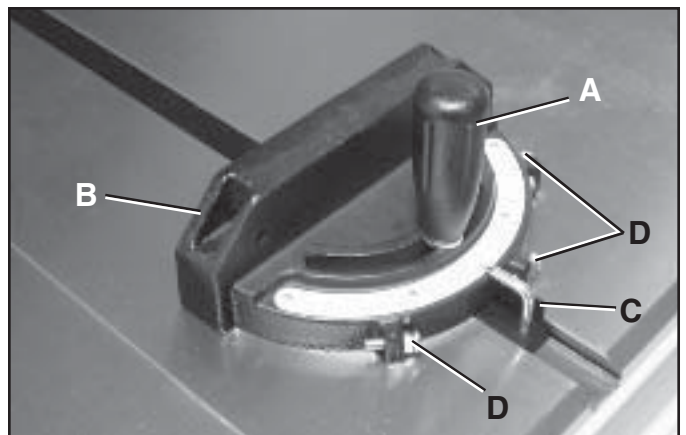

MITER GAUGE OPERATION

1. Operate miter gauge by loosening lock knob (A) and turning miter body (B) to desired angle. To move gauge beyond index stops of 45° and 90°, flip down stop (C). **SEE FIG. 9.**
2. Adjust index stops by turning one of three adjustment screws (D).

Note: Always make test cuts. Do not rely solely on miter gauge indicator marks.

BLADE RAISING AND TILTING MECHANISM

Fig. 10

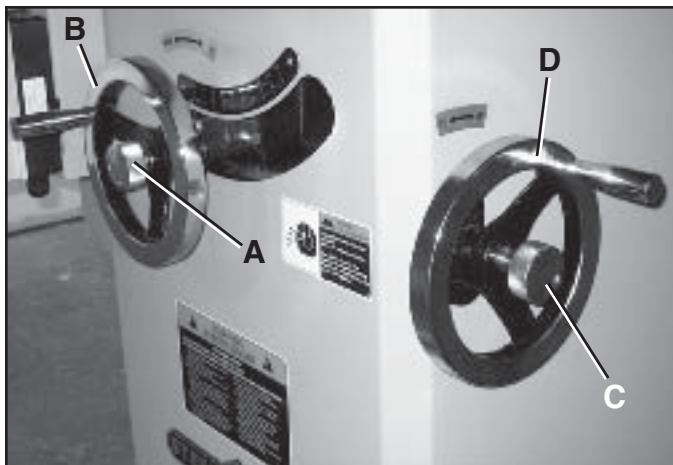

1. To raise or lower the saw blade, loosen the lock knob (A) in the middle of the handwheel and turn the handwheel (B) on the saw front until desired height is reached. Tighten lock knob. **SEE FIG. 10.**
2. To tilt the saw blade, loosen lock knob (C), turn handwheel on the right of the saw cabinet (D) until desired angle is obtained, then tighten lock knob.

ON/OFF SWITCH

The on and off switch is **thermally protected**. If the saw motor is overloaded, or a momentary interruption of electrical current is sensed, the saw will shut off. Allow a few minutes for the saw to cool down and **reset by pushing the off button (A)**. **SEE FIG. 11.**

Using extension cords can cause a loss in power to your machine. It is best if the saw is plugged directly into an outlet on a dedicated circuit. If using an extension cord, refer to chart in the Grounding Instructions section to determine proper gauge and length.

Fig. 11

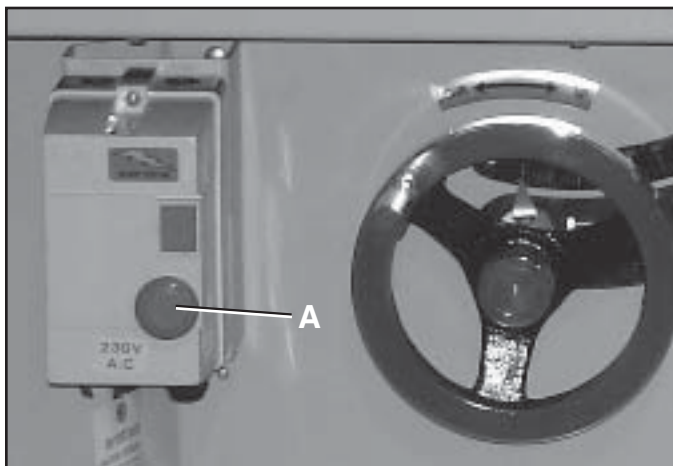

BLADE ALIGNMENT

Blade alignment with the table is adjusted at the factory. After a period of use, or after moving the saw to another location, the blade may no longer be aligned with the table. To check and align the blade:

▲ WARNING

MAKE CERTAIN THAT THE SAW IS DISCONNECTED FROM THE POWER SOURCE.

Fig. 12

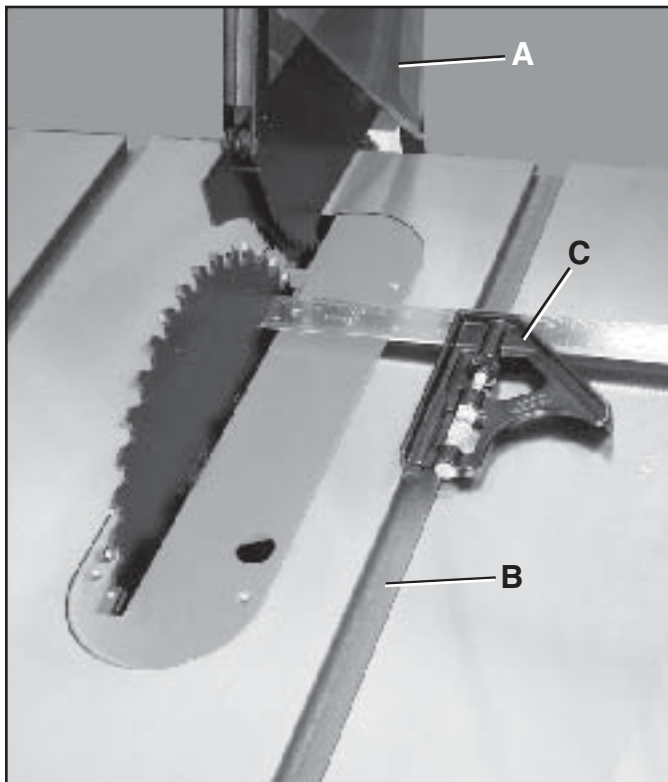

1. Raise the blade guard (A) up and out of the way of the blade. **SEE FIG. 12.**
2. Unlock fence and move away from the blade so as to expose the right miter slot (B).
3. Choose a tooth on the far side of the blade and directly over the back side of the insert. Mark the tooth with a marker. Measure the distance from the side of the blade to the right miter slot edge using a combination square (C). Make sure to measure between the teeth, not on the tooth.
4. Rotate the blade toward the front so that the marked tooth is just above the front side of the insert. Measure the distance from the side of the blade to the right miter slot edge. The two measurements should be the same.

Fig. 13

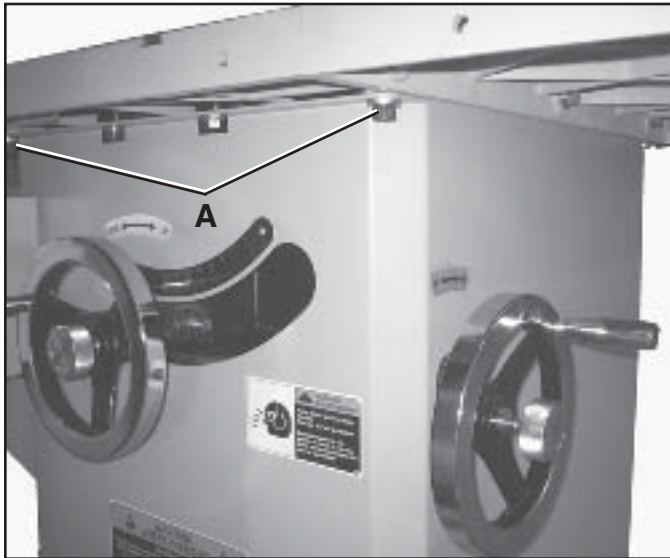

5. If they are not the same, loosen the four socket head cap screws (A) that hold the table to the base. Two are shown in Fig. 13; the other two are on the back corners of the machine. **SEE FIG. 13.**
6. Make the needed adjustments and tighten the four hex socket cap screws firmly.
7. Check the alignment once again after tightening hardware.

ADJUSTING 45° AND 90° POSITIVE STOPS

The stops have been adjusted at the factory. After a period of use, or, after moving the saw to another location, the stops may no longer be set properly. To check and adjust the stops:

⚠ WARNING

MAKE CERTAIN THAT THE SAW IS DISCONNECTED FROM THE POWER SOURCE.

1. Raise the saw blade to its maximum height using the handwheel.
2. Set the blade at 90 degrees to the table by turning the blade tilting handwheel clockwise as far as it will go.

Fig. 14

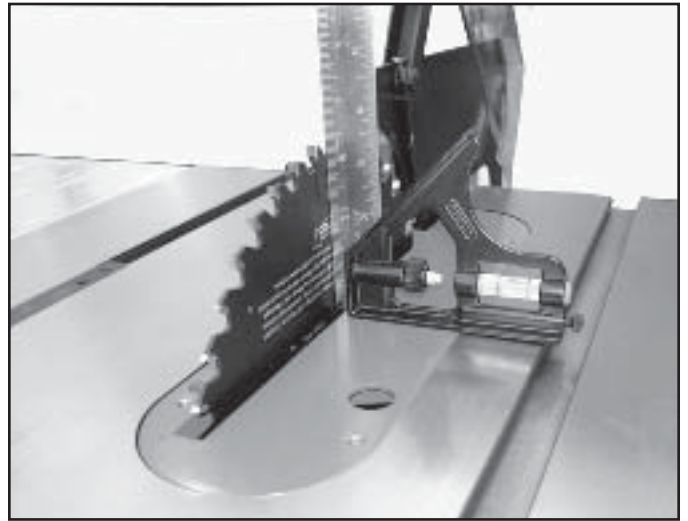

3. Place a square on the table and check to see that the blade is at a 90° angle to the table. Make sure square is not touching a blade tooth. **SEE FIG. 14.**

Fig. 15

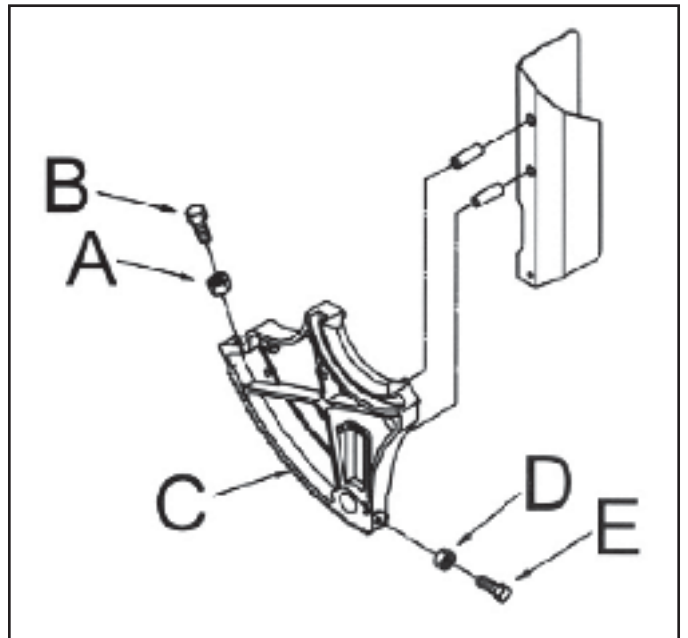

4. If blade is not at 90 degrees, open the motor cover door, loosen lock nut (A) and turn adjusting stop screw (B) on the front trunnion (C) in or out. The adjusting stop screw (B) should stop against the front trunnion bracket when the blade is 90 degrees to the table. **SEE FIG. 15.**

Fig. 16

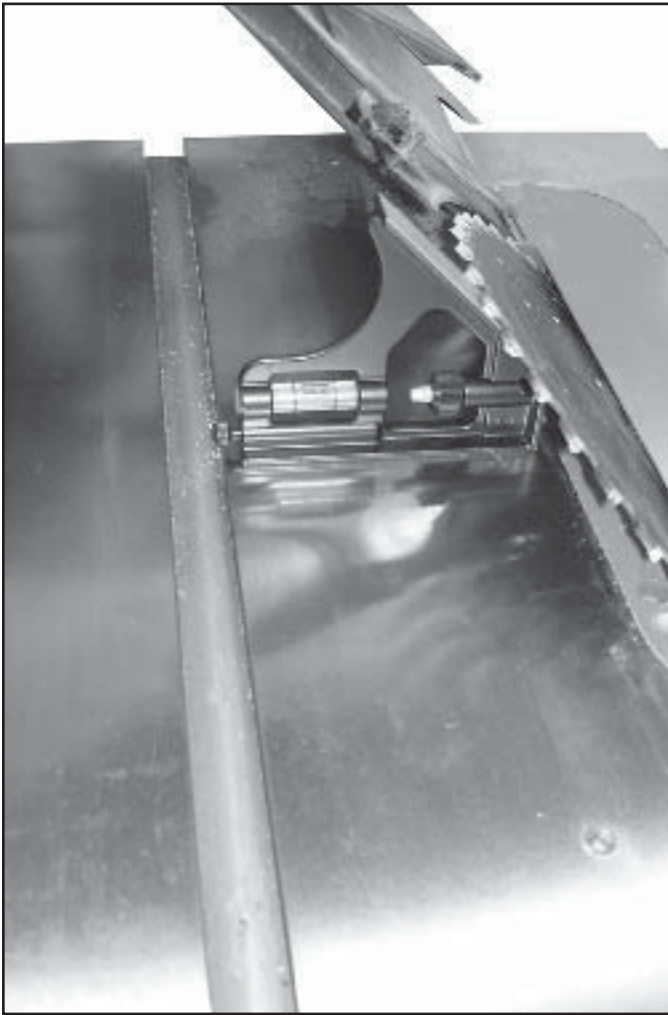

MOUNTING RAILS, FENCE AND EXTENSION TABLE

With the extension wings properly aligned, the rail and fence assembly can now be mounted to the saw. See the Owner's Manual for the Fence Assembly Instructions. This will address the mounting of the rails and fence.

5. Tighten locknut (A)
6. Set the blade at 45 degrees to the table by turning the blade tilting handwheel counterclockwise as far as it will go. Place a square on the table.
SEE FIG. 16.
7. If the blade is not at 45 degrees, loosen lock nut (D) and turn adjusting stop screw (E) on the front trunnion (C) in or out. The adjusting stop screw (E) should stop against the front trunnion bracket when the blade is 45 degrees to the table.
SEE FIG 15.
8. Check the accuracy of the pointer on the angle scale and adjust if necessary.

OPERATIONS

⚠ WARNING

MAKE CERTAIN THAT THE SAW IS DISCONNECTED FROM THE POWER SOURCE.

⚠ WARNING

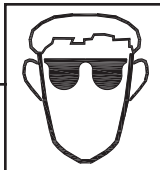

ALWAYS wear eye protection. Any machine can throw debris into the eyes during operations, which could cause severe and permanent eye damage. Everyday eyeglasses are **NOT** safety glasses. **ALWAYS** wear Safety Goggles (that comply with ANSI standard Z87.1) when operating power tools.

⚠ WARNING

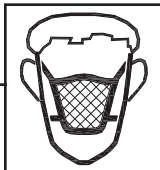

ALWAYS wear a NIOSH/OSHA approved dust mask to prevent inhaling dangerous dust or airborne particles.

⚠ WARNING

The following section was designed to give instructions on the basic operations of this table saw. However, it is in no way comprehensive of every table saw application. It is strongly recommended that you read books, trade magazines, or get formal training to maximize the potential of your table saw and to minimize the risks.

PRE-RUN CHECK

⚠ WARNING

MAKE CERTAIN THAT THE SAW IS DISCONNECTED FROM THE POWER SOURCE.

Before you begin to use your Table Saw, you should give it a thorough inspection, making sure you ask yourself the following questions:

1. Is the blade mounted correctly?
2. Is the saw stable?
3. Is it wired properly?
4. Is the electrical system properly configured?
5. Have you checked your workpiece for obvious defects?
6. Is the guard assembly installed and functional?
7. Have you checked the saw blade clearance when it is adjusted to varying angles and depths?
8. Have you read all the warnings and directions regarding the operation of this machine?

TEST RUN

1. Face the table saw and stand to the left of the blade path.
2. With one finger on the START button and one finger on the STOP button, turn the saw on. Be ready to turn the saw off in case of a mishap.
3. Watch and listen to the saw. Note whether there are any unusual sounds or excessive vibrations.
4. If anything appears abnormal, immediately turn off the saw, unplug it, and fix the problems. If a problem exists that is beyond the scope of this manual, contact your dealer.
5. If the saw is operating properly, turn it off and prepare to make a cut according to the instructions outlined in this section.

BLADE SELECTION

Choosing the correct blade for the job is essential for the safe and efficient use of your table saw. Ignoring this important step could result in damage to the saw and serious injury to the operator. Below are the most common saw blades and their uses.

1. **Rip Blade:** Used for cutting with the grain. Typically, 12" rip blades have between 18-40 teeth and large gullets to allow for large chip removal. **SEE FIG. 19.**

Fig. 19

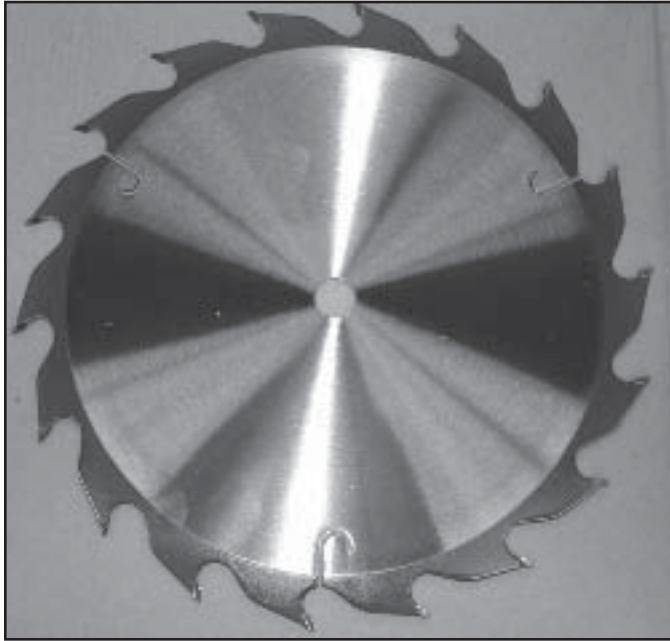

2. **Cross-cut Blade:** Used for cutting across the grain. 12" cross-cut blades have between 60-80 teeth and a shallow gullet. **SEE FIG. 20.**

Fig. 20

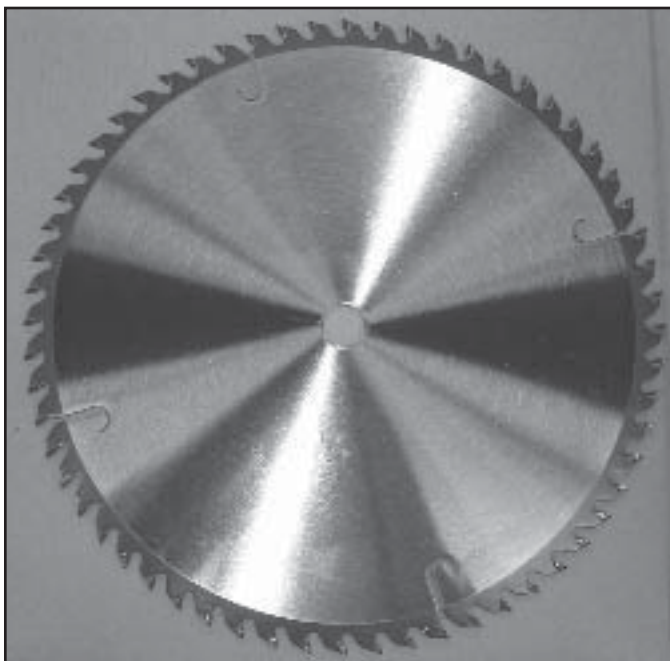

3. **Combination Blade:** Used for cutting with and across the grain. A compromise between a rip blade and a cross-cut blade, a 12" combination blade will typically have between 40-50 teeth. **SEE FIG. 21.**

Fig. 21

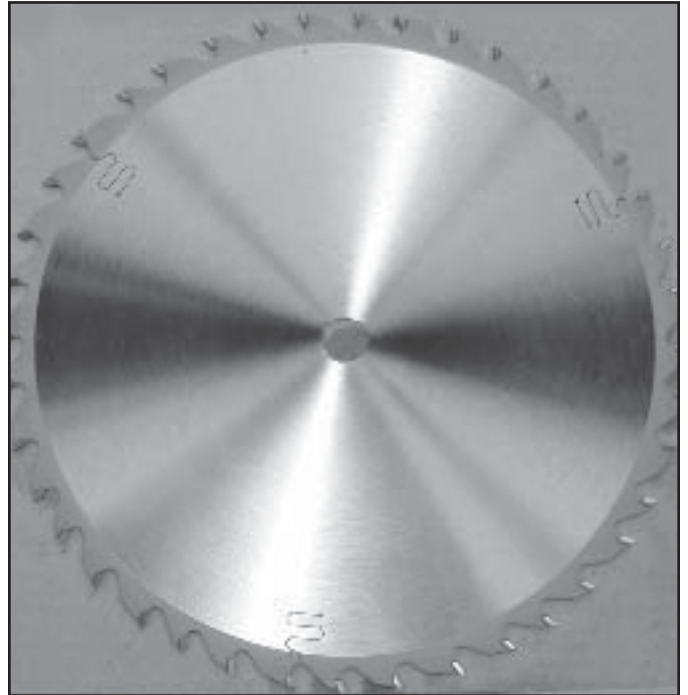

4. **Thin-kerf blade:** Most types of saw blades are available in a thin-kerf style. Designed primarily to minimize stock waste, thin-kerf blades are used in conjunction with a blade stabilizer to reduce blade wobble. **Note:** Many blade guards/splitters are thicker than many thin-kerf blades. Make sure that the stock will pass by the guard/splitter before beginning a cut.
5. **Dado Blades:** There are two types of dado blades: stack and wobble. Stack dados involve more set-up time, but they provide a superior finish cut when compared to a wobble dado. Dado blades require use of accessory dado table insert.
6. **Moulding Heads:** A moulding head is a cutterhead that attaches to the arbor and holds individual moulding knives. They are very dangerous and require training beyond the scope of this manual.

This section on blade selection is by no means comprehensive. Always follow the saw blade manufacturer's recommendations to assure safe and efficient operation of your table saw.

CROSSCUTTING

Crosscutting means cutting across the grain of the wood. In wood products without grain (i.e. MDF, particleboard), crosscutting simply means cutting across the width of the stock.

Crosscuts are made with the miter gauge. There are two miter gauge slots in the table top. Use the one that works best for the piece being crosscut. **To make a crosscut using the miter gauge:**

1. Inspect the board for soundness. You do not necessarily need a square edge to crosscut with accuracy.
2. Inspect the miter gauge. Is it properly set and tight?
3. Move the rip fence completely out of the way.
4. Turn on the saw and allow it to come to full speed.
5. Hold the workpiece firmly against the face of the miter gauge and ease it into the blade and through the workpiece. **SEE FIG. 22.**

Fig. 22

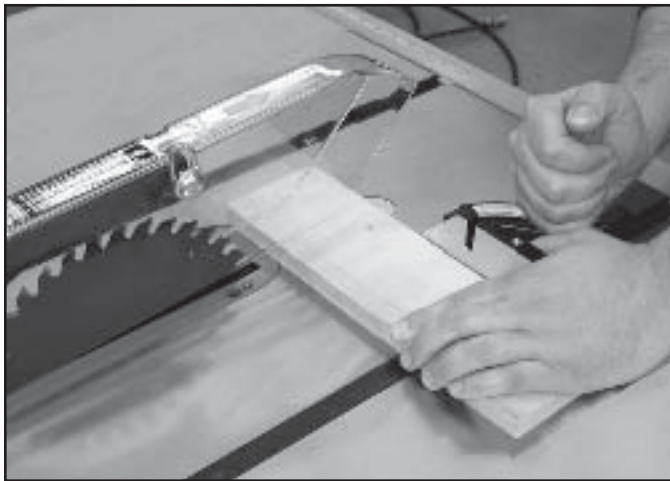

6. Turn off the saw and allow the blade to come to a full stop.

⚠ WARNING

Small cutoff pieces can contact the moving blade and be thrown back toward the operator. Always use the least amount of clearance between the table insert and the blade to reduce the risk of injury from these pieces. Never attempt to grab these pieces while the table saw is turned on. Your hand may come into contact with the blade. Turn the table saw off and safely remove these pieces **AFTER** the blade has come to a complete stop.

RIPPING

Ripping means to cut with the grain of the wood. In other materials such as MDF or plywood, ripping simply means to cut lengthwise. **To rip a board:**

1. Inspect the board for soundness. You will need a straight edge to rip with accuracy. Your workpiece may need to be jointed flat before attempting to cut on the table saw.

⚠ WARNING

Never attempt to rip a board that does not have one perfectly straight edge and one flat side on it. Always run the straight edge of the board against the rip fence. Failure to do this could result in kickback and serious personal injury.

2. Set the rip fence to the desired distance from the blade. **IF YOU ARE MAKING NARROW CUTS, USE A PUSH-STICK.** Serious injury can occur if you put your hands close to the blade. A push-stick pattern has been included at the end of this manual. Use it to hold the workpiece against the table and fence and push the workpiece fully past the blade. When a small width is to be ripped and a push-stick cannot be safely put between the blade and rip fence, rip a larger piece to obtain the desired piece.
3. Turn on the saw and allow it to reach full speed. Place the straight edge of the board against the rip fence and the flat side on the tabletop. Feed the workpiece slowly and evenly into the blade. When ripping, always stand off to the side of the workpiece and push it through, making sure to keep your fingers out of line with the blade. **SEE FIG. 23.**

Fig. 23



Do not stand directly behind the workpiece when ripping. SEE FIG. 24.

Fig. 24



⚠ WARNING

Stand out of the line of potential kickback. Hold the workpiece firmly against the fence and table. Do not allow your fingers to get close to the blade! Do not reach over the blade to off-load the workpiece.

DADO OPERATIONS

In addition to its ability to rip and crosscut lumber, the table saw is also an invaluable tool for creating a variety of dados. These non-through cuts can be created with specially-designed stacking or wobbling dado blades.

⚠ WARNING

Never allow hands or arms to be above or behind the saw blade. Should kickback occur, the hands and arms can be pulled into the saw blade. Serious injury will result.

⚠ WARNING

Never perform a through cut operation with a dado blade. A dado blade is designed to make non-through cuts only. Failure to follow these directions could result in serious injury.

⚠ WARNING

Dado operations present very real hazards requiring proper procedures to avoid serious injury. The chance of kickback is always greater when dado blades are used so extra precautions must be used. Any movement of the stock away from the fence can cause kickback. Be certain that stock is flat and straight. Failure to follow these warnings could result in serious personal injury.

⚠ WARNING

Always use push sticks, featherboards, push paddles and other safety accessories whenever possible to increase safety and control during operations which require the blade guard and splitter to be removed from the saw. ALWAYS replace the blade guard after dadoing is complete.

Proper dado operations will differ depending on the blade system you choose. Consult the instructions included with your dado blades for directions regarding attachment and adjustment. To use a dado blade:

⚠ WARNING

MAKE CERTAIN THAT THE SAW IS DISCONNECTED FROM THE POWER SOURCE.

1. Remove the table insert, splitter guard, and regular saw blade.
2. Attach and adjust the dado blade system as recommended in the dado blade's instructions.
3. Install the dado table insert.
4. Raise the blade system up to the desired depth of the dado. Make sure the dado blade will not cut through the workpiece.
5. Reconnect the saw to the power source.
6. If dadoing along the length of your workpiece, adjust the distance between the fence and the inside edge of the blade to suit your needs. When cutting across the wood grain, use the miter gauge as a guide while dadoing. **Remember:** Never use the fence as a stop in conjunction with your miter gauge.
7. Using a scrap piece as a test piece, switch on the saw and take a pass over the dado blade.
8. If the cut is satisfactory, repeat with your finish stock.
9. Avoid taking too deep a cut in a single pass. Make incremental cuts to avoid kickback.

MAINTENANCE

This table saw requires very little maintenance other than minor lubrication and cleaning. The following sections detail what will need to be done in order to assure continued operation of your saw.

⚠ WARNING

MAKE CERTAIN THAT THE SAW IS DISCONNECTED FROM THE POWER SOURCE.

LUBRICATION

The table saw has sealed lubricated bearings in the motor housing and the arbor assembly that do not require any additional lubrication from the operator.

Use a wire brush to clean off the worm gears and trunnions and apply a white lithium grease to keep them lubricated.

CLEANING

Keep the inside of the cabinet clear of saw dust and wood chips. With the table saw unplugged, vacuum out the inside of the cabinet or blow out the inside with an air hose. Be sure to use air pressure no higher than 50 P.S.I. as high pressure air may damage insulation. The tabletop is an unfinished metal surface that, over time, will accumulate rust if not properly cared for. When the table saw is not in use, keep a light coat of WD-40 on the table top as this will help prevent rust from occurring. If rust has already accumulated on the table, use WD-40 and a fine steel wool to get rid of the rust. Using a quality paste wax on the tabletop and wings is a good preventative measure to help prevent rust from forming.

⚠ WARNING

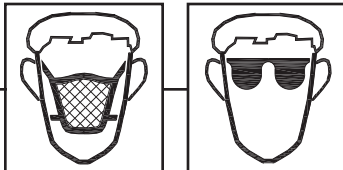

Be sure to wear protective eyewear and dust mask when cleaning out the cabinet of the saw.

CHANGING BELTS

⚠ WARNING

MAKE CERTAIN THAT THE SAW IS DISCONNECTED FROM THE POWER SOURCE.

Fig. 1

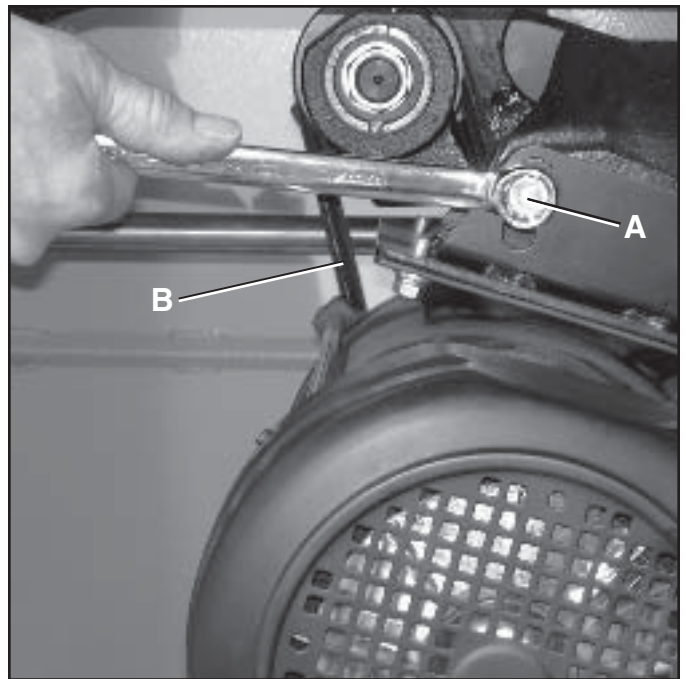

1. Lower the blade to its lowest point.
2. Loosen one hex cap bolts (A). **SEE FIG. 1.**
3. Take the tension off of the belts (B) by lifting up on the motor.
4. Remove the belts from the arbor and motor pulleys.
5. Replace and tension the belts. The weight of the motor should apply enough tension to the belts. Tighten the hex cap bolts.
6. Check the belt tension after the saw has been used for a few hours. Adjust as necessary.
7. Use only Steel City replacement parts.

TROUBLESHOOTING GUIDE

This section covers the most common processing problems encountered in sawing and what to do about them. Do not make any adjustments until the table saw is unplugged from the power source and moving parts have come to a complete stop.

PROBLEM	LIKELY CAUSE(S)	SOLUTION
Saw stops or will not start.	<ol style="list-style-type: none"> 1. Overload tripped. 2. Saw unplugged from wall or motor. 3. Fuse blown or circuit breaker tripped. 4. Cord damaged. 	<ol style="list-style-type: none"> 1. Allow motor to cool and reset by pushing off switch. 2. Check all plug connections. 3. Replace fuse or reset circuit breaker. 4. Replace cord.
Does not make accurate 45° or 90° cuts.	<ol style="list-style-type: none"> 1. Stops not adjusted correctly. 2. Angle pointer not set accurately. 3. Miter gauge out of adjustment. 	<ol style="list-style-type: none"> 1. Check blade with square and adjust stops. 2. Check blade with square and adjust pointer. 3. Adjust miter gauge.
Material binds blade when ripping.	<ol style="list-style-type: none"> 1. Fence not aligned with blade. 2. Warped wood. 3. Excessive feed rate. 4. Splitter not aligned with blade. 	<ol style="list-style-type: none"> 1. Check and adjust fence. 2. Select another piece of wood. 3. Reduce feed rate. 4. Align splitter with blade.
Saw makes unsatisfactory cuts.	<ol style="list-style-type: none"> 1. Dull blade. 2. Blade mounted backwards. 3. Gum or pitch on blade. 4. Incorrect blade for cut. 5. Gum or pitch on table. 	<ol style="list-style-type: none"> 1. Sharpen or replace blade. 2. Properly mount blade. 3. Remove blade and clean. 4. Change blade to correct type. 5. Clean table.
Blade does not come up to speed.	<ol style="list-style-type: none"> 1. Extension cord too light or too long. 2. Low shop voltage. 3. Motor not wired for correct voltage. 	<ol style="list-style-type: none"> 1. Replace with adequate size cord. 2. Contact your local electric company. 3. Refer to motor junction box.
Saw vibrates excessively.	<ol style="list-style-type: none"> 1. Stand on uneven floor. 2. Damaged saw blade. 3. Bad V-belts. 4. Bent pulley. 5. Improper motor mounting. 6. Loose hardware. 7. Loose set screw in pulley. 	<ol style="list-style-type: none"> 1. Reposition on flat, level surface. 2. Replace saw blade. 3. Replace V-belts. 4. Replace pulley. 5. Check and adjust motor. 6. Tighten hardware. 7. Tighten set screw.
Rip fence binds on guide rails.	<ol style="list-style-type: none"> 1. Guide rails or extension wing not installed correctly. 2. Guide of rip fence not adjusted properly. 	<ol style="list-style-type: none"> 1. Reassemble guide rails, refer to fence manual. 2. Adjust guides, refer to fence manual.
Material kicked back from blade.	<ol style="list-style-type: none"> 1. Rip fence out of alignment. 2. Splitter not aligned with blade. 3. Feeding stock without rip fence. 4. Splitter not in place. 5. Dull blade. 6. Letting go of material before it is past blade. 7. Anti-kickback fingers dull. 	<ol style="list-style-type: none"> 1. Align rip fence with miter slot and blade. 2. Align splitter with blade. 3. Install and use rip fence. 4. Install and use splitter (with guard). 5. Replace blade. 6. Push material all the way past blade before releasing work. 7. Replace or sharpen anti-kickback fingers.
Blade does not raise or tilt freely.	<ol style="list-style-type: none"> 1. Sawdust and debris in raising and tilting mechanisms. 	<ol style="list-style-type: none"> 1. Clean and grease.

◆ NOTES ◆

PARTS

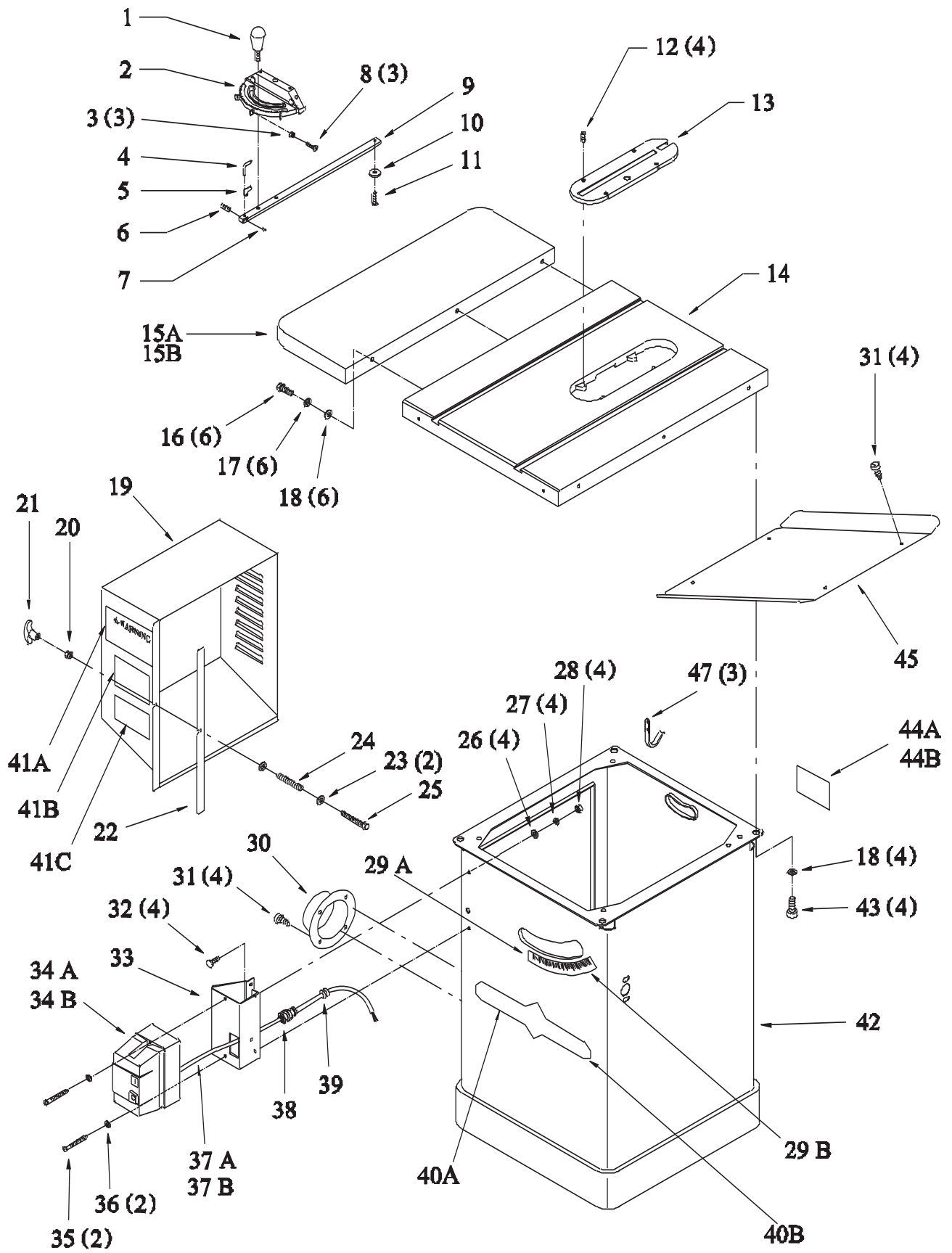

KEY NO.	PART NO.	DESCRIPTION	QTY.	KEY NO.	PART NO.	DESCRIPTION	QTY.
1	OR70450	Miter Gage Lock Knob	1	28	OR90071	Hex Nut 1/4	4
2	OR70451	Miter Gage Body	1	29A	OR70602	Tilt Scale	1
3	OR90381	Hex Nut M5	3	29B	OR93823	Rivet	2
4	OR70452	Pointer	1	30	OR70473	Dust Hose Adapter	1
5	OR70453	Stop	1	31	OR93821	Tap Screw M5 x 10	8
6	OR93812	Set Screw M5 x 5	1	32	OR90460	Carriage Bolt 1/4 x 3/4	4
7	OR93813	Special Pin 3mm x 6mm	1	33	OR70475	Switch Plate	1
8	OR93814	Pan Head Screw M5 x 20	3	34A	OR70603	Switch (Magnetic, 7.5HP, 3PH, 230V)	1
9	OR70457	Guide Bar	1	34B	OR70476	Switch (Magnetic, 1PH, 230V)	1
10	OR70458	Guide Washer	1	35	OR93822	Screw 3/16 x 3/4	2
11	OR91805	Flat Head Screw M6 x 8	1	36	OR90462	Flat Washer M5	2
12	OR91789	Set Screw 1/4 x 3/8	4	37A	OR70604	Power Cord (Switch to Motor, 7.5HP, 3ph, 230V)	1
13	OR70598	Table Insert	1	37B	OR70605	Power Cord (Switch to Motor, 1ph, 230V)	1
14	OR70599	Table	1	38	OR70479	Cable Strain Relief	1
15A	OR70600	Extension Wing, LEFT 11"	1	39	OR70480	Cable Bushing	1
15B	OR73636	Extension Wing, RIGHT 11"	1	40A	OR70484	Nameplate	1
16	OR93815	Hex Socket Cap Screw 7/16 x 1 1/2	6	40B	OR93823	Rivet	4
17	OR93816	Lock Washer 7/16	6	41A	OR70481	Warning Label	1
18	OR93817	Flat Washer 7/16 x 25mm x 3mm	10	41B	OR70482	Kickback Warning Label	1
19	OR70601	Motor Cover	1	41C	OR70483	Ear & Eye Protection Label	1
20	OR90235	Hex Nut M6	1	42	OR70606	Cabinet	1
21	OR70467	Handle	1	43	OR93824	Hex Socket Cap Screw 7/16 x 3/4	4
22	OR70468	Foam Strip	1	44A	OR70306	Serial Number Plate (7.5HP, 3PH, 230V)	1
23	OR90059	Flat Washer M6	2	44B	OR70307	Serial Number Plate (1PH, 230V)	1
24	OR93818	Spring	1	45	OR70609	Dust Chute	1
25	OR93819	Hex Head Screw M6 x 50	1	46	OR70490	Junction Box Assembly (Not Shown)	1
26	OR90060	Flat Washer 1/4	4	47	OR70594	Tool Hook	3
27	OR90070	Lock Washer 1/4	4				

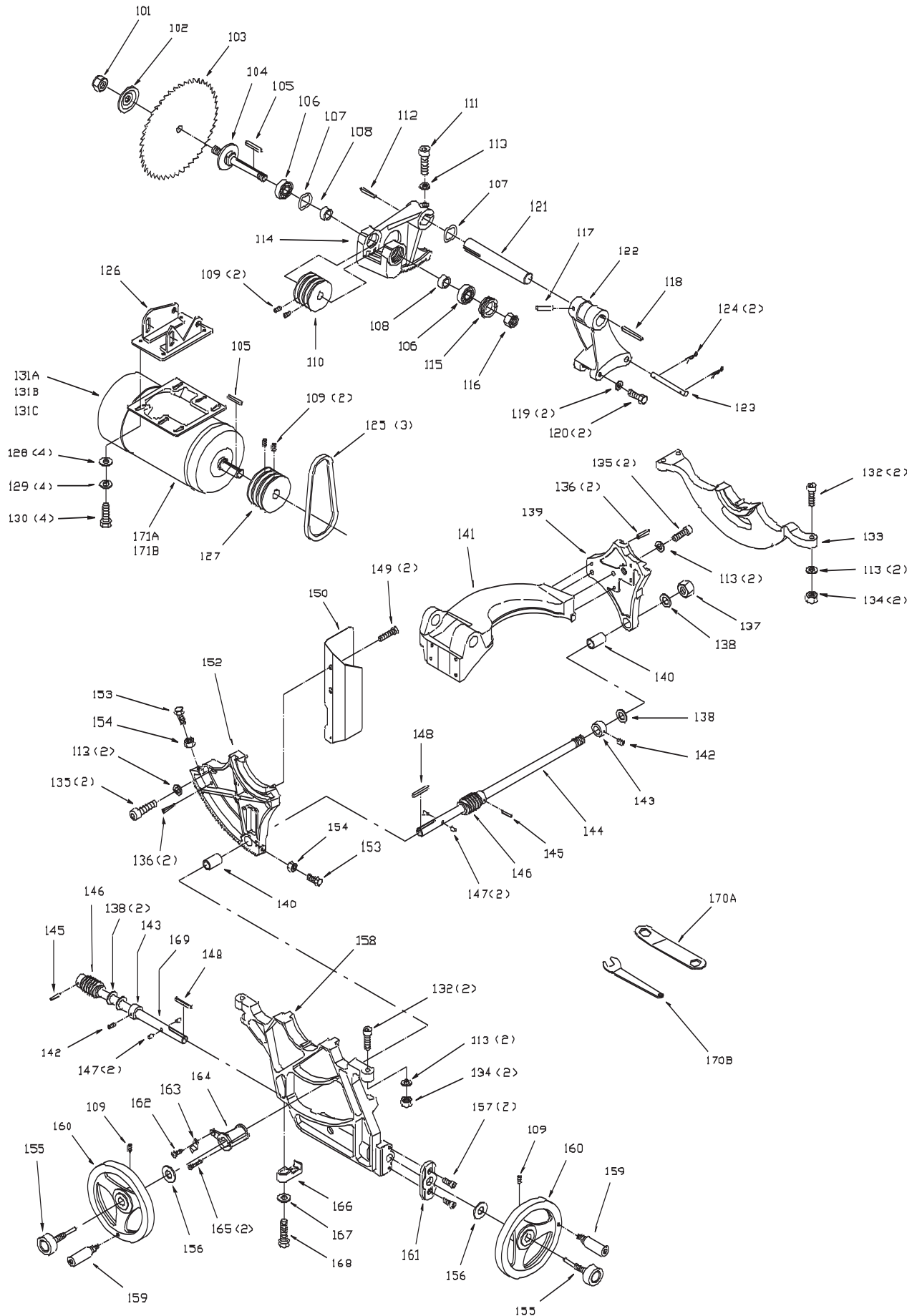

KEY NO.	PART NO.	DESCRIPTION	QTY.	KEY NO.	PART NO.	DESCRIPTION	QTY.
101	OR70610	Arbor Nut	1	136	OR93877	Spring Pin 8mm x 25mm	4
102	OR70611	Arbor Flange	1	137	OR93876	Hex Nut 3/4	1
103	OR70612	Blade	1	138	OR93841	Fiber Washer	4
104	OR70613	Arbor	1	139	OR70624	Rear Trunnion	1
105	OR70495	Key 5mm x 5mm x 44mm	2	140	OR70625	Bushing	2
106	OR93887	Ball Bearing	2	141	OR70626	Yoke	1
107	OR93826	Wave Washer	2	142	OR93874	Hex Socket Set Screw 5/16 - 18 x 1/4	4
108	OR70614	Spacer	2	143	OR70547	Collar	2
109	OR91789	Set Screw 1/4 x 3/8	6	144	OR70628	Shaft (Blade Raising & Lowering)	1
110	OR70615	Arbor Pulley	1	145	OR93840	Spring Pin 5mm x 28 mm	2
111	OR93884	Hex Socket Cap Screw 3/8 - 16 x 1 3/4	1	146	OR70629	Worm Gear	2
112	OR93883	Key 5mm x 5mm x 50mm	1	147	OR70534	Lock Pin	4
113	OR90647	Lock Washer 3/8	10	148	OR70536	Key 5mm x 5mm x 35mm	2
114	OR70616	Arbor Bracket	1	149	OR90272	Hex Socket Cap Screw M8 x 12mm	2
115	OR70617	Spanner Nut	1	150	OR70631	Dust Deflector	1
116	OR93876	Hex Nut 3/4	1	152	OR70632	Front Trunnion	1
117	OR93882	Spring Pin 6mm x 50mm	1	153	OR90466	Hex Head Screw 5/16 -18 x 3/4	2
118	OR93881	Key 1/4 x 1/4 x 75mm	1	154	OR93843	Hex Nut 5/16	2
119	OR93816	Flat Washer 7/16 x 25mm x 3mm	2	155	OR70551	Lock Knob	1
120	OR93880	Hex Head Screw 7/16 -14 x 1	2	156	OR93849	Fiber Washer	2
121	OR70618	Shaft	1	157	OR93846	Hex Socket Cap Screw 5/16 - 18 x 1 1/2	2
122	OR70619	Motor Bracket	1	158	OR70634	Front Trunnion Bracket	1
123	OR70620	Pin	1	159	OR70541	Hand Wheel Handle	2
124	OR93879	Spring Clip	2	160	OR70542	Handle	2
125	OR93888	V-Belt	3	161	OR70544	Adapter Plate	1
126	OR70621	Motor Plate	1	162	OR93848	Pan Head Screw 1/4 - 20 x 3/8	1
127	OR70519	Motor Pulley	1	163	OR70549	Pointer	1
128	OR90064	Flat Washer 5/16	4	164	OR70637	Pointer Bracket	1
129	OR90386	Lock Washer 5/16	4	165	OR93869	Pan Head Screw 10 -32 x 2	2
130	OR90640	Hex Head Screw 5/16 x 3/4	4	166	OR70638	Guide Block	1
131A	OR70402	Motor (1PH,230V)	1	167	OR90467	Flat Washer 3/8	1
131B	OR70352	Motor Specification Plate	1	168	OR93833	Hex Head Screw 3/8 x 1 1/2	1
131C	OR93889	Capacitor (250 MFD)	1	169	OR70639	Shaft (Blade Tilt)	1
132	OR93837	Hex Socket Cap Screw 3/8 - 16 x 1 1/2	5	170A	OR70640	Wrench	1
133	OR70623	Rear Trunnion Bracket	1	170B	OR70641	Wrench	1
134	OR90369	Hex Nut 3/8	5	171A	OR70403	Motor (7.5HP, 3PH , 230V)	
135	OR93878	Hex Socket Cap Screw 3/8 - 16 x 1	4	1171B	OR70351	Motor Specification Plate	1

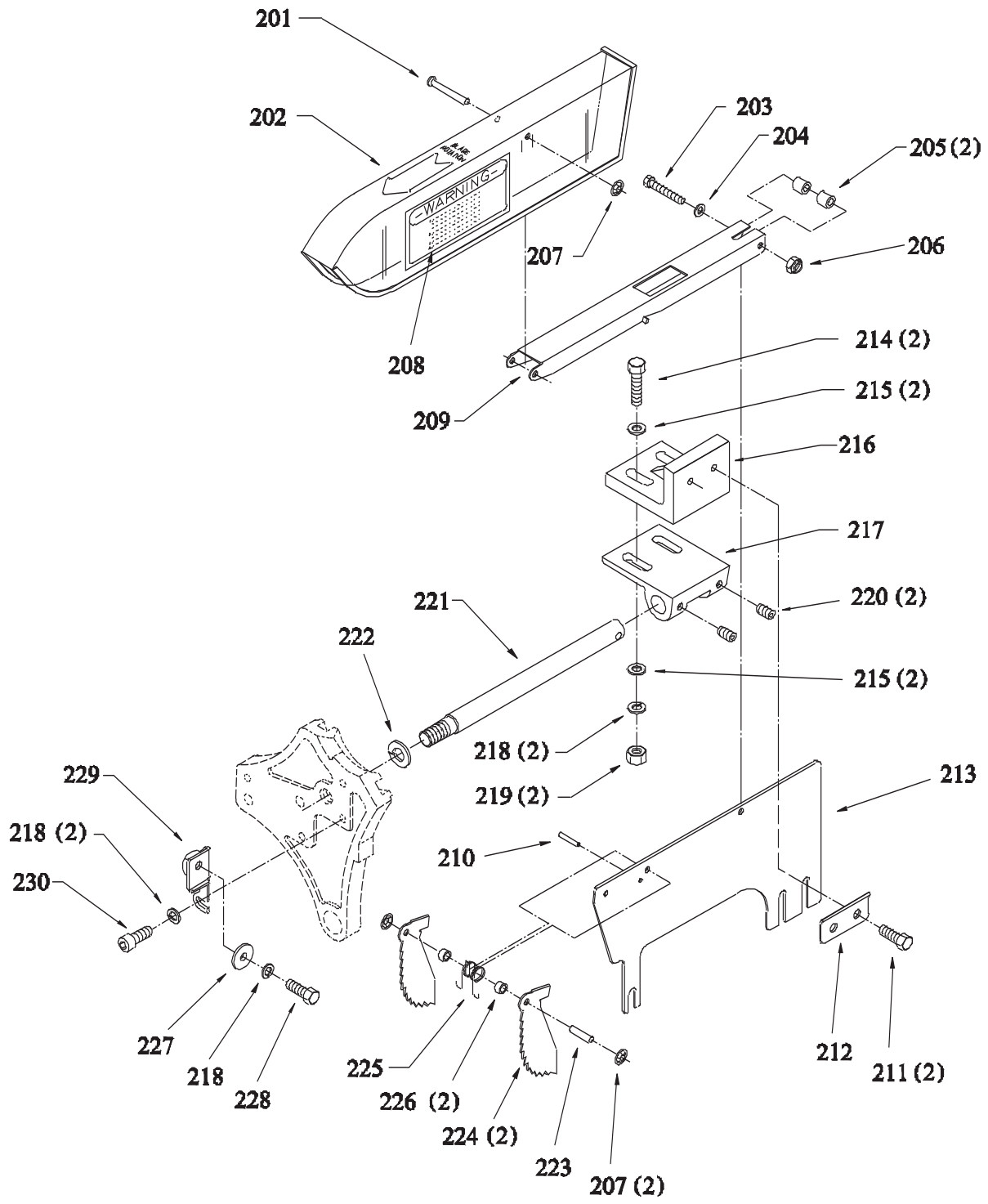

KEY NO.	PART NO.	DESCRIPTION	QTY.	KEY NO.	PART NO.	DESCRIPTION	QTY.
201	OR70554	Pin	1	217	OR70565	Lower Blade Guard Bracket	1
202	OR70643	Guard	1	218	OR90386	Lock Washer 5/16	5
203	OR93850	Hex Head Screw 1/4 - 20 x 1 1/2	1	219	OR90616	Hex Nut 5/16	2
204	OR90060	Flat Washer 1/4	1	220	OR93853	Hex Socket Set Screw 5/16 -18 x 3/8	2
205	OR70644	Spacer	2	221	OR70567	Shaft	1
206	OR93851	Nylok Hex Nut 1/4	1	222	OR93854	Lock Washer 5/8	1
207	OR93852	Push Nut 6mm	3	223	OR91797	Spring Pin 6mm x 26mm	1
208	OR70560	Warning Label	1	224	OR70651	Anti-Kickback Finger	2
209	OR70645	Support Arm	1	225	OR70652	Spring	1
210	OR91796	Spring Pin 4mm x 24mm	1	226	OR70571	Spacer	2
211	OR90634	Hex Head Bolt 5/16 -18 x 1	2	227	OR90064	Flat Washer 5/16	1
212	OR70562	Plate	1	228	OR90635	Hex Head Bolt 5/16 - 18 x 5/8	1
213	OR70647	Splitter	1	229	OR70654	Bracket	1
214	OR91649	Hex Head Bolt 5/16 - 18 x 1 1/2	2	230	OR93868	Hex Socket Cap Screw 5/16 - 18 x 1/2	2
215	OR90064	Flat Washer 5/16	6	231	OR70655	Owners Manual (Owners Manual)	1
216	OR70564	Upper Blade Guard Bracket	1				

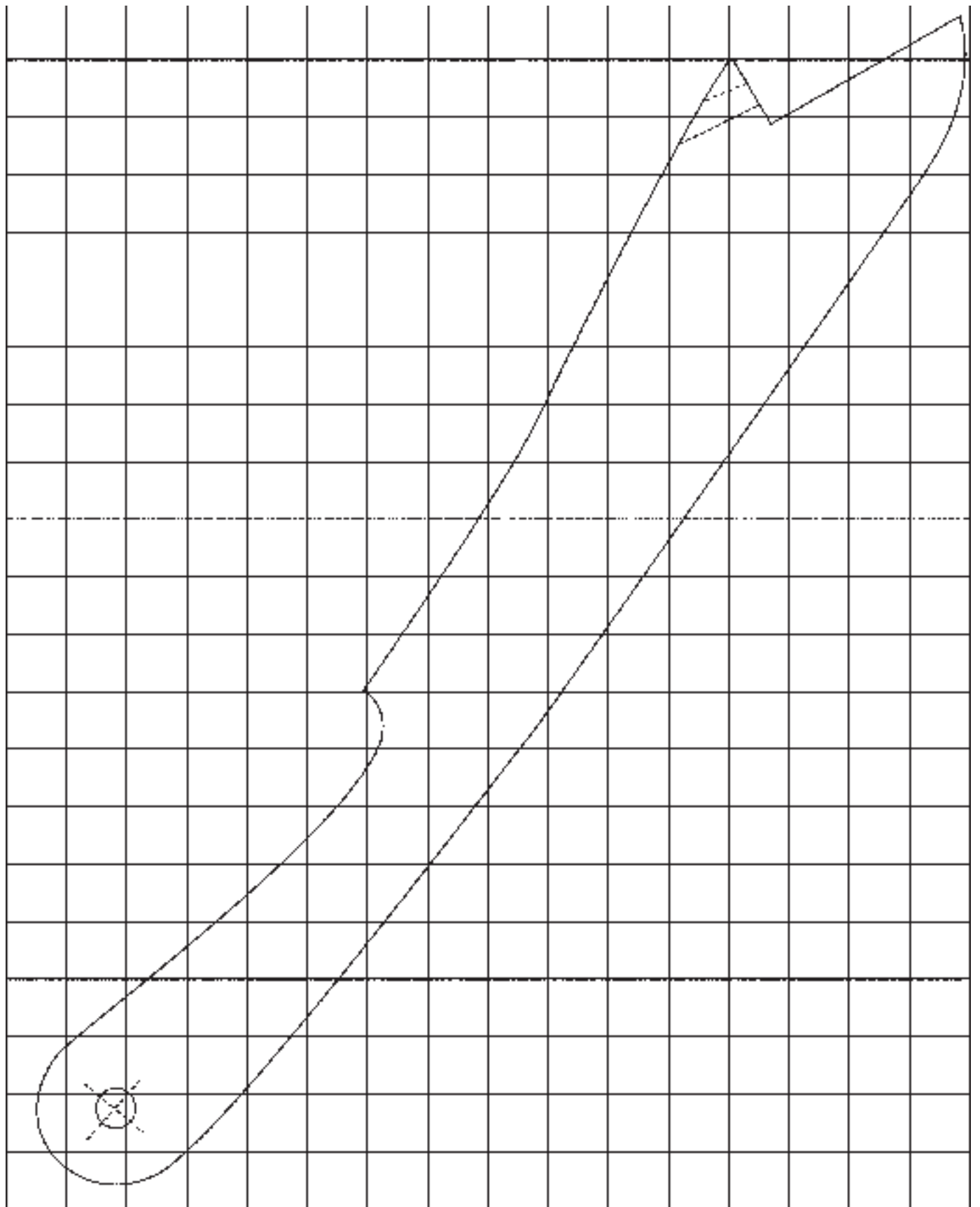

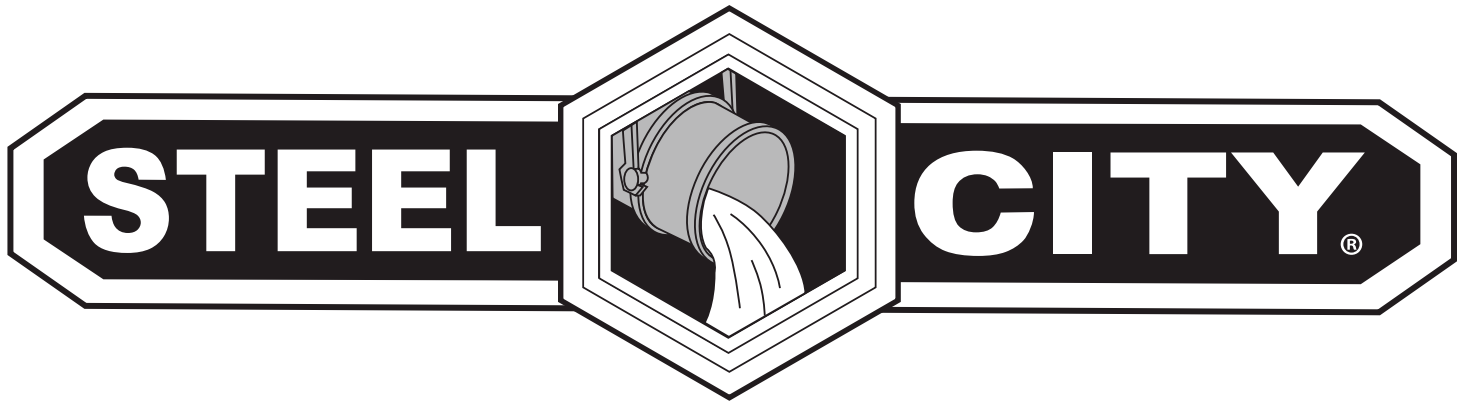

STEEL CITY TOOL WORKS

www.steelcitytoolworks.com

1-877-SC4-TOOL
(1-877-724-8665)

NOTES

www.steelcitytoolworks.com

Steel City Tool Works, LLC Bolingbrook, IL. USA 60440

Tech Service: 1.877.724.8665