



User Manual

Read and understand this manual before using machine.

OSCILLATING SPINDLE SANDER



**Model Number
55200**





THANK YOU for purchasing your new Steel City Oscillating Spindle Sander. This oscillating spindle sander has been designed, tested, and inspected with you, the customer, in mind. When properly used and maintained, your oscillating spindle sander will provide you with years of trouble free service, which is why it is backed by one of the longest machinery warranties in the business.

This oscillating spindle sander is just one of many products in the Steel City's family of woodworking machinery and is proof of our commitment to total customer satisfaction.

At Steel City we continue to strive for excellence each and every day and value the opinion of you, our customer. For comments about your oscillating spindle sander or Steel City Tool Works, please visit our web site at www.steelcitytoolworks.com .

TABLE OF CONTENTS

INTRODUCTION

SECTION 1	Warranty	4
SECTION 2	Product Specifications	7
SECTION 3	Accessories and Attachments	7
SECTION 4	Feature Identification	8
SECTION 5	General Safety	9
SECTION 6	Product Safety	11
SECTION 7	Electrical Requirements	12
SECTION 8	Unpacking & Inventory	14
SECTION 9	Assembly	15
SECTION 10	Adjustments	17
SECTION 11	Operations	19
SECTION 12	Maintenance	20
SECTION 13	Troubleshooting	21
SECTION 14	Parts List.....	22-27

INTRODUCTION

This user manual is intended for use by anyone working with this machine. It should be kept available for immediate reference so that all operations can be performed with maximum efficiency and safety. Do not attempt to perform maintenance or operate this machine until you have read and understand the information contained in this manual.

The drawings, illustrations, photographs, and specifications in this user manual represent your machine at time of print. However, changes may be made to your machine or this manual at any time with no obligation to Steel City Tool Works.

WARRANTY

STEEL CITY TOOL WORKS 5 YEAR LIMITED WARRANTY

Steel City Tool Works, LLC (“SCTW”) warrants all “STEEL CITY TOOL WORKS” machinery to be free of defects in workmanship and materials for a period of 5 years from the date of the original retail purchase by the original owner. SCTW will repair or replace, at its expense and at its option, any SCTW machine, machine part, or machine accessory which in normal use has proven to be defective, provided that the customer returns the product, shipping prepaid, to an authorized service center with proof of purchase and provides SCTW with a reasonable opportunity to verify the alleged defect by inspection. This warranty does not apply to defects due directly or indirectly to misuse, abuse, negligence, accidents, or lack of maintenance, or to repairs or alterations made or specifically authorized by anyone other than SCTW. Normal wear components are also excluded under this coverage. Every effort has been made to ensure that all SCTW machinery meets the highest quality and durability standards. We reserve the right to change specifications at any time due to our commitment to continuous improvement of the quality of our products.

EXCEPT AS SET FORTH ABOVE, SCTW MAKES NO EXPRESS OR IMPLIED REPRESENTATIONS OR WARRANTIES WITH RESPECT TO ITS MACHINERY, OR ITS CONDITION, MERCHANTABILITY, OR FITNESS FOR ANY PARTICULAR PURPOSE OR USE. SCTW FURNISHES THE ABOVE WARRANTIES IN LIEU OF ALL OTHER WARRANTIES, EXPRESS OR IMPLIED, INCLUDING THE WARRANTIES OF MERCHANTABILITY AND FITNESS FOR A PARTICULAR PURPOSE, WHICH ARE HEREBY SPECIFICALLY DISCLAIMED.

SCTW SHALL NOT BE LIABLE FOR ANY (A) SPECIAL, INDIRECT, INCIDENTAL, PUNITIVE OR CONSEQUENTIAL DAMAGES, INCLUDING WITHOUT LIMITATION LOSS OF PROFITS, ARISING FROM OR RELATED TO THIS WARRANTY, THE BREACH OF ANY AGREEMENT OR WARRANTY, OR THE OPERATION OR USE OF ITS MACHINERY, INCLUDING WITHOUT LIMITATION DAMAGES ARISING FROM DAMAGE TO FIXTURES, TOOLS, EQUIPMENT, PARTS OR MATERIALS, DIRECT OR INDIRECT LOSS CAUSED BY ANY OTHER PARTY, LOSS OF REVENUE OR PROFITS, FINANCING OR INTEREST CHARGES, AND CLAIMS BY ANY THIRD PERSON, WHETHER OR NOT NOTICE OF SUCH POSSIBLE DAMAGES HAS BEEN GIVEN TO SCTW; (B) DAMAGES OF ANY KIND FOR ANY DELAY BY OR FAILURE OF SCTW TO PERFORM ITS OBLIGATIONS UNDER THIS AGREEMENT; OR (C) CLAIMS MADE A SUBJECT OF A LEGAL PROCEEDING AGAINST SCTW MORE THAN ONE (1) YEAR AFTER SUCH CAUSE OF ACTION FIRST AROSE.

The validity, construction and performance of this Warranty and any sale of machinery by SCTW shall be governed by the laws of the Commonwealth of Pennsylvania, without regard to conflicts of laws provisions of any jurisdiction. Any action related in any way to any alleged or actual offer, acceptance or sale by SCTW, or any claim related to the performance of any agreement including without limitation this Warranty, shall take place in the federal or state courts in Allegheny County, Pennsylvania.

STEEL CITY TOOL WORKS

WARRANTY CARD

Name _____
Street _____
Apt. No. _____
City _____ State _____ Zip _____
Phone Number _____
E-Mail _____

Product Description: _____
Model No.: _____
Serial No. _____

The following information is given on a voluntary basis and is strictly confidential.

1. Where did you purchase your STEEL CITY machine?
Store: _____
City: _____

2. How did you first learn of Steel City Tool Works?
 Advertisement Mail Order Catalog
 Web Site Friend
 Local Store Other _____

3. Which of the following magazines do you subscribe to?
 American Woodworker American How-To
 Cabinetmaker Family Handyman
 Fine Homebuilding Fine Woodworking
 Journal of Light Construction Old House Journal
 Popular Mechanics Popular Science
 Popular Woodworking Today's Homeowner
 WOOD Woodcraft
 WOODEN Boat Woodshop News
 Woodsmith Woodwork
 Woodworker Woodworker's Journal
 Workbench Other _____

4. Which of the following woodworking / remodeling shows do you watch?
 Backyard America The American Woodworker
 Home Time The New Yankee Workshop
 This Old House Woodwright's Shop
Other _____

5. What is your annual household income?
 \$20,000 to \$29,999 \$30,000 to \$39,999
 \$40,000 to \$49,999 \$50,000 to \$59,999
 \$60,000 to \$69,999 70,000 to \$79,999
 \$80,000 to \$89,999 \$90,000 +

6. What is your age group?
 20 to 29 years 30 to 39 years
 40 to 49 years 50 to 59 years
 60 to 69 years 70 + years

7. How long have you been a woodworker?
 0 to 2 years 2 to 8 years
 8 to 20 years over 20 years

8. How would you rank your woodworking skills?
 Simple Intermediate
 Advance Master Craftsman

9. How many Steel City machines do you own? _____

10. What stationary woodworking tools do you own?
Check all that apply.
 Air Compressor Band Saw
 Drill Press Drum Sander
 Dust Collection Horizontal Boring Machine
 Jointer Lathe
 Mortiser Panel Saw
 Planer Power Feeder
 Radial Arm Saw Shaper
 Spindle Sander Table Saw
 Vacuum Veneer Press Wide Belt Sander
Other _____

11. Which benchtop tools do you own? *Check all that apply.*
 Belt Sander Belt / Disc Sander
 Drill Press Band Saw
 Grinder Mini Jointer
 Mini Lathe Scroll Saw
 Spindle / Belt Sander Other _____

12. Which portable / hand held power tools do you own?
Check all that apply.
 Belt Sander Biscuit Jointer
 Dust Collector Circular Saw
 Detail Sander Drill / Driver
 Miter Saw Orbital Sander
 Palm Sander Portable Thickness Planer
 Saber Saw Reciprocating Saw
 Router Other _____

13. What machines / accessories would you like to see added to the STEEL CITY line?

14. What new accessories would you like to see added?

15. Do you think your purchase represents good value?
 Yes No

16. Would you recommend STEEL CITY products to a friend?
 Yes No

17. Comments:

CUT HERE

FOLD ON DOTTED LINE

PLACE
STAMP
HERE

Steel City Tool Works
P.O. Box 10529
Murfreesboro, TN 37129

FOLD ON DOTTED LINE

PRODUCT SPECIFICATIONS

MOTOR

Type	TEFC, Induction, Ball Bearing
Continuous Duty Horsepower	1 HP
Amps	10/5
Voltage	115/230
Phase	Single
Hertz	60
RPM	1725 (no load)

PRODUCT DIMENSIONS

Footprint	18-1/2" x 18-1/2"
Length	18-1/2"
Width	18-1/2"
Height	39"
Weight	298 lbs.

SHIPPING DIMENSIONS

Carton Type	Cardboard
Length	25"
Width	25-3/4"
Height	42-1/2"
Gross Weight	343 Lbs.

PRODUCT SPECIFICATIONS

Table Size	24" x 24"
Table Tilt	0-45 degrees with positive stops
Table Height from Floor	39"
Dust Port Size	4"
Spindle Speed	1725 RPM
Spindle Diameters	1/4", 3/8", 1/2", 5/8", 3/4", 1", 1-1/2", 2", 3", 4"
Spindle Lengths	5", 6", 9"
Spindle Oscillations Per Minute	75
Length of Oscillation	1-1/2"
Arbor Size	3/4"
Total Arbor Length	10-3/4"

ACCESSORIES AND ATTACHMENTS

There are a variety of accessories available for your Steel City Product. For more information on any accessories associated with this and other machines, please contact your nearest Steel City distributor, or visit our website at: www.steelcitytoolworks.com.

FEATURE IDENTIFICATION

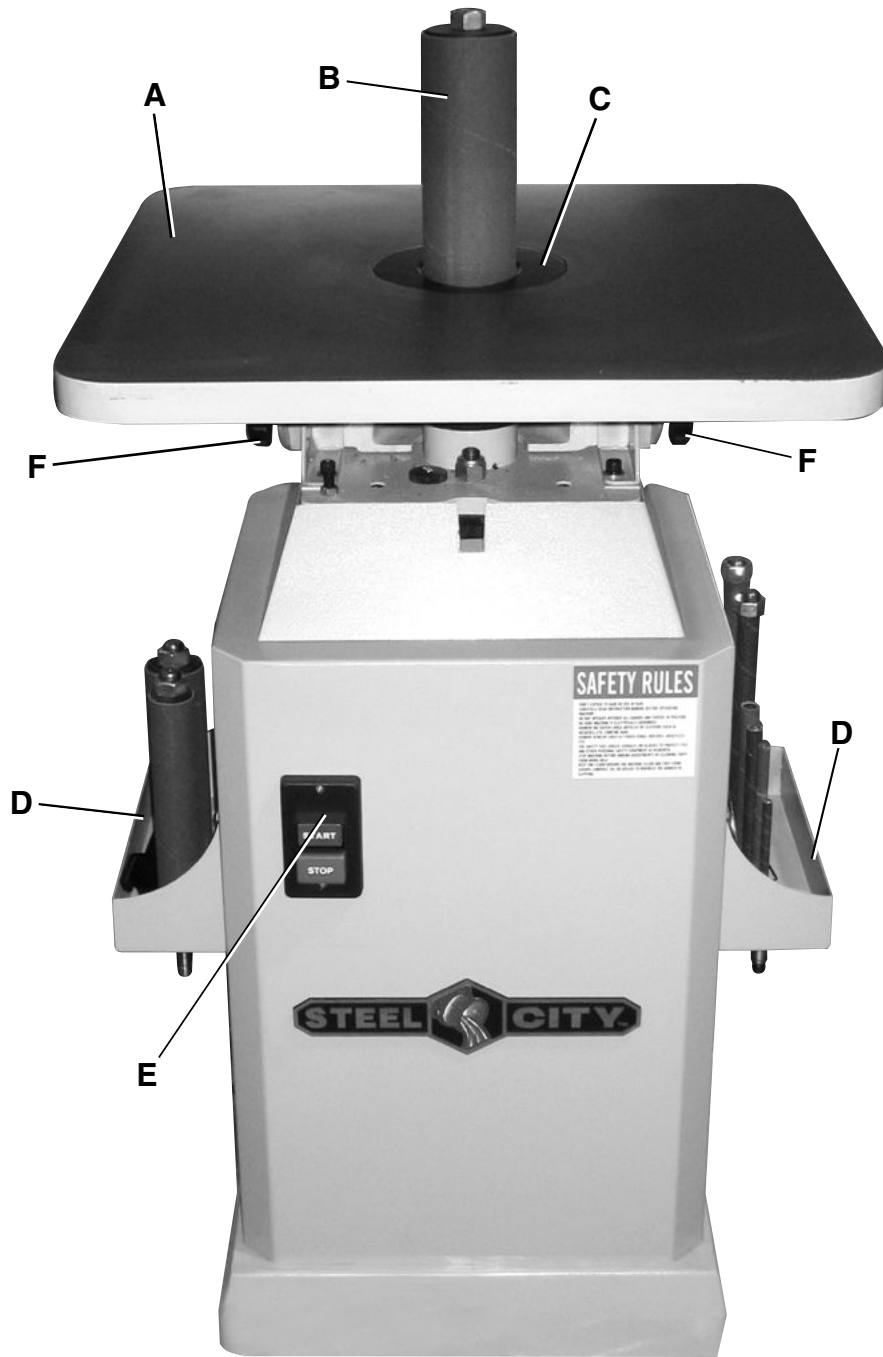

- A) Table
- B) Sanding Drum
- C) Table Insert

- D) Spindle Trays (2)
- E) START/STOP Switch
- F) Table Tilting Lock Knobs (2)

GENERAL SAFETY

⚠ WARNING

TO AVOID serious injury and damage to the machine, read and follow all Safety and Operating Instructions before assembling and operating this machine.

This manual is not totally comprehensive. It does not and can not convey every possible safety and operational problem which may arise while using this machine. The manual will cover many of the basic and specific safety procedures needed in an industrial environment.

All federal and state laws and any regulations having jurisdiction covering the safety requirements for use of this machine take precedence over the statements in this manual. Users of this machine must adhere to all such regulations.

Below is a list of symbols that are used to attract your attention to possible dangerous conditions.



This is the safety alert symbol. It is used to alert you to potential personal injury hazards. Obey all safety messages that follow this symbol to avoid possible injury or death.

⚠ DANGER

Indicates an imminently hazardous situation which, if not avoided, **WILL** result in death or serious injury.

⚠ WARNING

Indicates a potentially hazardous situation which, if not avoided, **COULD** result in death or serious injury.

⚠ CAUTION

Indicates a potentially hazardous situation, if not avoided, **MAY** result in minor or moderate injury. It may also be used to alert against unsafe practices.

CAUTION

CAUTION used without the safety alert symbol indicates a potentially hazardous situation which, if not avoided, may result in property damage.

NOTICE

This symbol is used to alert the user to useful information about proper operation of the machine.

⚠ WARNING

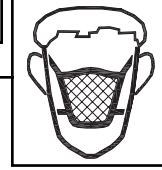

Exposure to the dust created by power sanding, sawing, grinding, drilling and other construction activities may cause serious and permanent respiratory or other injury, including silicosis (a serious lung disease), cancer, and death. Avoid breathing the dust, and avoid prolonged contact with dust. The dust may contain chemicals known to the State of California to cause cancer, birth defects or other reproductive harm.

Some examples of these chemicals are:

- Lead from lead-based paints.
- Crystalline silica from bricks, cement and other masonry products.
- Arsenic and chromium from chemically-treated lumber.

Always operate tool in well ventilated area and provide for proper dust removal. Use a dust collection system along with an air filtration system whenever possible. Always use properly fitting NIOSH/OSHA approved respiratory protection appropriate for the dust exposure, and wash exposed areas with soap and water.

1. To avoid serious injury and damage to the machine, read the entire User Manual before assembly and operation of this machine.

⚠ WARNING

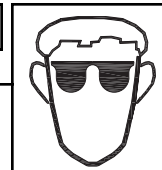

2. **ALWAYS** wear eye protection. Any machine can throw debris into the eyes during operations, which could cause severe and permanent eye damage. Everyday eyeglasses are **NOT** safety glasses. **ALWAYS** wear Safety Goggles (that comply with ANSI standard Z87.1) when operating power tools.

▲ WARNING

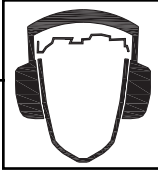

3. **ALWAYS** wear hearing protection. Plain cotton is not an acceptable protective device. Hearing equipment should comply with ANSI S3.19 Standards.

▲ WARNING

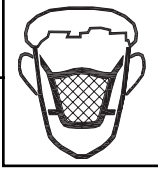

4. **ALWAYS** wear a NIOSH/OSHA approved dust mask to prevent inhaling dangerous dust or airborne particles.

5. **ALWAYS** keep the work area clean, well lit, and organized. **DO NOT** work in an area that has slippery floor surfaces from debris, grease, and wax.
6. **ALWAYS** unplug the machine from the electrical receptacle when making adjustments, changing parts or performing any maintenance.
7. **AVOID ACCIDENTAL STARTING.** Make sure that the power switch is in the "OFF" position before plugging in the power cord to the electrical receptacle.

▲ WARNING

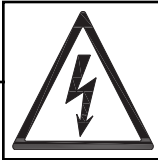

8. **AVOID** a dangerous working environment. **DO NOT** use electrical tools in a damp environment or expose them to rain or moisture.

▲ WARNING



9. **CHILDPROOF THE WORKSHOP AREA** by removing switch keys, unplugging tools from the electrical receptacles, and using padlocks.

10. **DO NOT** use electrical tools in the presence of flammable liquids or gasses.

11. **DO NOT FORCE** the machine to perform an operation for which it was not designed. It will do a safer and higher quality job by only performing operations for which the machine was intended.
12. **DO NOT** stand on a machine. Serious injury could result if it tips over or you accidentally contact any moving part.
13. **DO NOT** store anything above or near the machine.
14. **DO NOT** operate any machine or tool if under the influence of drugs, alcohol, or medication.
15. **EACH AND EVERY** time, check for damaged parts prior to using any machine. Carefully check all guards to see that they operate properly, are not damaged, and perform their intended functions. Check for alignment, binding or breakage of all moving parts. Any guard or other part that is damaged should be immediately repaired or replaced.
16. Ground all machines. If any machine is supplied with a 3-prong plug, it must be plugged into a 3-contact electrical receptacle. The third prong is used to ground the tool and provide protection against accidental electric shock. **DO NOT** remove the third prong.
17. Keep visitors and children away from any machine. **DO NOT** permit people to be in the immediate work area, especially when the machine is operating.
18. **KEEP** protective guards in place and in working order.
19. **MAINTAIN** your balance. **DO NOT** extend yourself over the tool. Wear oil resistant rubber soled shoes. Keep floor clear of debris, grease, and wax.
20. **MAINTAIN** all machines with care. **ALWAYS KEEP** machine clean and in good working order. **KEEP** all blades and tool bits sharp.
21. **NEVER** leave a machine running, unattended. Turn the power switch to the OFF position. **DO NOT** leave the machine until it has come to a complete stop.
22. **REMOVE ALL MAINTENANCE TOOLS** from the immediate area prior to turning the machine ON.
23. **SECURE** all work. When it is possible, use clamps or jigs to secure the workpiece. This is safer than attempting to hold the workpiece with your hands.
24. **STAY ALERT**, watch what you are doing, and use common sense when operating any machine. **DO NOT** operate any machine tool while tired or under the influence of drugs, alcohol, or medication. A moment of inattention while operating power tools may result in serious personal injury.

25. **USE ONLY** recommended accessories. Use of incorrect or improper accessories could cause serious injury to the operator and cause damage to the machine. If in doubt, **DO NOT** use it.
26. **THE USE** of extension cords is not recommended for 230V equipment. It is better to arrange the placement of your equipment and the installed wiring to eliminate the need for an extension cord. If an extension cord is necessary, refer to the chart in the Grounding Instructions section to determine the minimum gauge for the extension cord. The extension cord must also contain a ground wire and plug pin.
27. Wear proper clothing, **DO NOT** wear loose clothing, gloves, neckties, or jewelry. These items can get caught in the machine during operations and pull the operator into the moving parts. Users must wear a protective cover on their hair, if the hair is long, to prevent it from contacting any moving parts.
28. **SAVE** these instructions and refer to them frequently and use them to instruct other users.
29. Information regarding the safe and proper operation of this tool is also available from the following sources:

Power Tool Institute
 1300 Summer Avenue
 Cleveland, OH 44115-2851
www.powertoolinstitute.org

National Safety Council
 1121 Spring Lake Drive
 Itasca, IL 60143-3201

American National Standards Institute
 25 West 43rd Street, 4th floor
 New York, NY 10036
www.ansi.org

ANSI 01.1 Safety Requirements for
 Woodworking Machines, and the U.S. Department
 of Labor regulations
www.osha.gov

PRODUCT SAFETY

1. Serious personal injury may occur if normal safety precautions are overlooked or ignored. Accidents are frequently caused by lack of familiarity or failure to pay attention. Obtain advice from supervisor, instructor, or another qualified individual who is familiar with this machine and its operations.
2. Every work area is different. Always consider safety first, as it applies to your work area. Use this machine with respect and caution. Failure to do so could result in serious personal injury and damage to the machine.

3. Prevent electrical shock. Follow all electrical and safety codes, including the National Electrical Code (NEC) and the Occupational Safety and Health Regulations (OSHA). All electrical connections and wiring should be made by qualified personnel only.

▲ WARNING

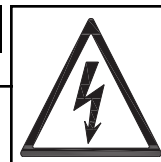

4. **TO REDUCE** the risk of electrical shock. **DO NOT** use this machine outdoors. **DO NOT** expose to rain or moisture. Store indoors in a dry area.

5. **STOP** using this machine, if at any time you experience difficulties in performing any operation. Contact your supervisor, instructor or machine service center immediately.
6. Safety decals are on this machine to warn and direct you to how to protect yourself or visitors from personal injury. These decals **MUST** be maintained so that they are legible. **REPLACE** decals that are not legible.
7. **DO NOT** leave the unit plugged into the electrical outlet. Unplug the unit from the outlet when not in use and before servicing, performing maintenance tasks, or cleaning.
8. **ALWAYS** turn the power switch "OFF" before unplugging the sander.

▲ WARNING

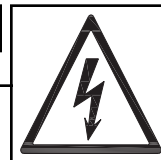

9. **DO NOT** handle the plug or sander with wet hands.

10. **USE** accessories only recommended by Steel City.
11. **DO NOT** pull the sander by the power cord. **NEVER** allow the power cord to come in contact with sharp edges, hot surfaces, oil or grease.
12. **DO NOT** unplug the sander by pulling on the power cord. **ALWAYS** grasp the plug, not the cord.
13. **REPLACE** a damaged cord immediately. **DO NOT** use a damaged cord or plug. If the sander is not operating properly, or has been damaged, left outdoors or has been in contact with water.
14. **DO NOT** use the sander as a toy. **DO NOT** use near or around children.

15. **BE SURE** that spindles are securely locked in the machine before starting.
16. **DO NOT** clear chips and dust when spindle is moving.
17. **ALWAYS** turn off the machine and disconnect the power before changing spindles.
18. **USE** appropriate support if sanding work pieces without a flat surface.
19. **BE SURE** that spindles are moving at normal operating speed before beginning to sand.
20. **BE SURE** that all tools have been removed from the work area before starting the machine.
21. **MAINTAIN A SECURE GRIP ON THE WORKPIECE.** The spindle rotates at 1725 RPM. If control is lost, the workpiece could be shot from the machine at extreme speed.
22. **CREATE A SAFETY ZONE AROUND THE SANDING SURFACE.** If you can't control your workpiece with your hands at least 6" away from the sanding sleeve, you should create a jig or other device to hold the workpiece safely.
23. **DON'T OPERATE THE SPINDLE SANDER** if the proper insert is not in place.
24. **REPLACE SLEEVES WHEN WORN OR DAMAGED.** A torn or damaged sleeve could be unexpectedly expelled from the machine if not replaced.
25. **KEEP YOUR WORKPIECE SOLIDLY ON THE SANDER TABLE.** A well-secured workpiece is less likely to lose control during sanding operations.
26. **INSPECT MATERIALS FOR DEFECTS.** Knots and splinters can shoot from the machine with great force. Make sure defective materials are not used on the spindle sander. Foreign objects such as nails and staples should also be removed before sanding.
27. **TURN OFF THE SANDER WHEN NOT IN USE.** Never leave a machine running unattended.
28. **ALWAYS** wear eye protection and a respirator.
29. **BE SURE TO OBSERVE ELECTRICAL REQUIREMENTS SUCH AS FUSE SIZING, WIRE SIZING, AND GROUNDING.**
30. **ENSURE THAT THE SWITCH IS IN THE OFF POSITION BEFORE PLUGGING THE MACHINE INTO ITS POWER SOURCE.**
31. **DO NOT** stand directly in line with sanding accessories when turning the machine on.
32. **DO NOT** force the workpiece against the spindle during operation. Firmly grasp the workpiece in both hands and ease it against the spindle using light pressure.
33. **DO NOT** wear loose clothing while operating this machine. Roll up sleeves or button sleeves at the cuff.
34. **DO NOT** place hands near, or in contact with sanding sleeve during operation.
35. **PERFORM MACHINE INSPECTIONS** and maintenance service promptly when called for.
36. **ANY PROBLEM** that is concerned at all with any moving parts or accessories must be investigated and corrected with the power disconnected, and after everything has come to a complete stop.
37. It cannot be assumed that additional safety measures are not needed under particular or exceptional circumstances or conditions. **CONSIDER SAFETY AT ALL TIMES.**

ELECTRICAL REQUIREMENTS

WARNING

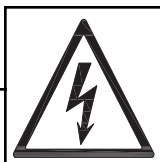

To reduce the risk of electric shock, follow all electrical and safety codes, including the National Electric Code (NEC) and the Occupational Safety and Health Regulations (OSHA). All electrical connections and wiring should be made by qualified personnel only.

The switch provided with your sander is a dual voltage capable switch, meaning it is designed to function at either 115 or 230 volts. The switch and sander comes prewired for 115 volt operation. If you decide to convert the sander to 230V, you will have to replace the 115 volt plug on the switch with a UL/CSA Listed plug, suitable for 230 volts. The sander with a 230 volt plug should only be connected to an outlet having the same configuration as the plug. No adapter is available or should be used with the 230 volt plug. Once the modification has been made to the plug of the switch, be sure to follow the instructions under CHANGING MOTOR VOLTAGE for changing the motor voltage from 115 volt to 230 volt in the ADJUSTMENTS section of this manual.

GROUNDING INSTRUCTIONS

⚠ WARNING



This machine **MUST BE GROUNDED** while in use to protect the operator from electric shock.

In the event of a malfunction or breakdown, **GROUNDING** provides the path of least resistance for electric current and reduces the risk of electric shock. The plug **MUST** be plugged into a matching electrical receptacle that is properly installed and grounded in accordance with **ALL** local codes and ordinances.

If a plug is provided with your machine **DO NOT** modify the plug. If it will not fit your electrical receptacle, have a qualified electrician install the proper connections to meet all electrical codes local and state. All connections must also adhere to all of OSHA mandates.

IMPROPER ELECTRICAL CONNECTION of the equipment-grounding conductor can result in risk of electric shock. The conductor with the green insulation (with or without yellow stripes) is the equipment-grounding conductor. **DO NOT** connect the equipment-grounding conductor to a live terminal if repair or replacement of the electric cord or plug is necessary.

Check with a qualified electrician or service personnel if you do not completely understand the grounding instructions, or if you are not sure the tool is properly grounded.

PLUGS/RECEPTACLES

⚠ WARNING



- Electrocutation or fire could result if this machine is not grounded properly or if the electrical configuration does not comply with local and state electrical codes.
- **MAKE CERTAIN** the machine is disconnected from power source before starting any electrical work.
- **MAKE SURE** the circuit breaker does not exceed the rating of the plug and receptacle.

The motor supplied with your machine is a 115/230 volt, dual voltage motor. Never connect the green or ground wire to a live terminal.

The machine should only be connected to an outlet having the same configuration as the plug.

EXTENSION CORDS

⚠ WARNING

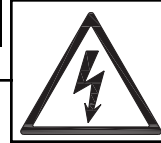

To reduce the risk of fire or electrical shock, use the proper gauge of extension cord. When using an extension cord, be sure to use one heavy enough to carry the current your machine will draw.

The smaller the gauge-number, the larger the diameter of the extension cord is. If in doubt of the proper size of an extension cord, use a shorter and thicker cord. An undersized cord will cause a drop in line voltage resulting in a loss of power and overheating.

⚠ CAUTION

USE ONLY a 3-wire extension cord that has a 3-prong grounding plug and a 3-pole receptacle that accepts the machine's plug.

If you are using an extension cord outdoors, be sure it is marked with the suffix "W-A" ("W" in Canada) to indicate that it is acceptable for outdoor use.

Make certain the extension cord is properly sized, and in good electrical condition. Always replace a worn or damaged extension cord immediately or have it repaired by a qualified person before using it.

Protect your extension cords from sharp objects, excessive heat, and damp or wet areas.

MINIMUM RECOMMENDED GAUGE FOR EXTENSION CORDS (AWG)			
115 VOLT OPERATION ONLY			
	25' LONG	50' LONG	100' LONG
0 to 6 Amps	18 AWG	16 AWG	16 AWG
6 to 10 Amps	18 AWG	16 AWG	14 AWG
10 to 12 Amps	16 AWG	16 AWG	14 AWG
12 to 15 Amps	14 AWG	12 AWG	Not recommended

MINIMUM RECOMMENDED GAUGE FOR EXTENSION CORDS (AWG)			
230 VOLT OPERATION ONLY			
	25' LONG	50' LONG	100' LONG
0 to 6 Amps	18 AWG	18 AWG	16 AWG
6 to 10 Amps	18 AWG	18 AWG	14 AWG
10 to 12 Amps	16 AWG	16 AWG	14 AWG
12 to 15 Amps	14 AWG	12 AWG	Not recommended

UNPACKING & INVENTORY

⚠ WARNING

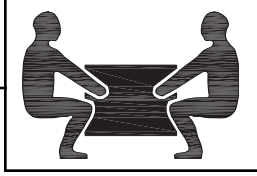

- The machine is heavy, two people are required to unpack and lift.
- Use a safety strap to avoid tip over when lifting machine.

Check shipping carton and machine for damage before unpacking. Carefully remove packaging materials, parts and machine from shipping carton. Always check for and remove protective shipping materials around motors and moving parts. Lay out all parts on a clean work surface.

Remove any protective materials and coatings from all of the parts and the sander. The protective coatings

can be removed by spraying WD-40 on them and wiping it off with a soft cloth. This may need redone several times before all of the protective coatings are removed completely.

After cleaning, apply a good quality paste wax to any unpainted surfaces. Make sure to buff out the wax before assembly.

Compare the items to inventory figures; verify that all items are accounted for before discarding the shipping box.

⚠ WARNING

If any parts are missing, do not attempt to plug in the power cord and turn "ON" the machine. The machine should only be turned "ON" after all the parts have been obtained and installed correctly. **For missing parts, contact Steel City at 1-877-SC4-TOOL.**

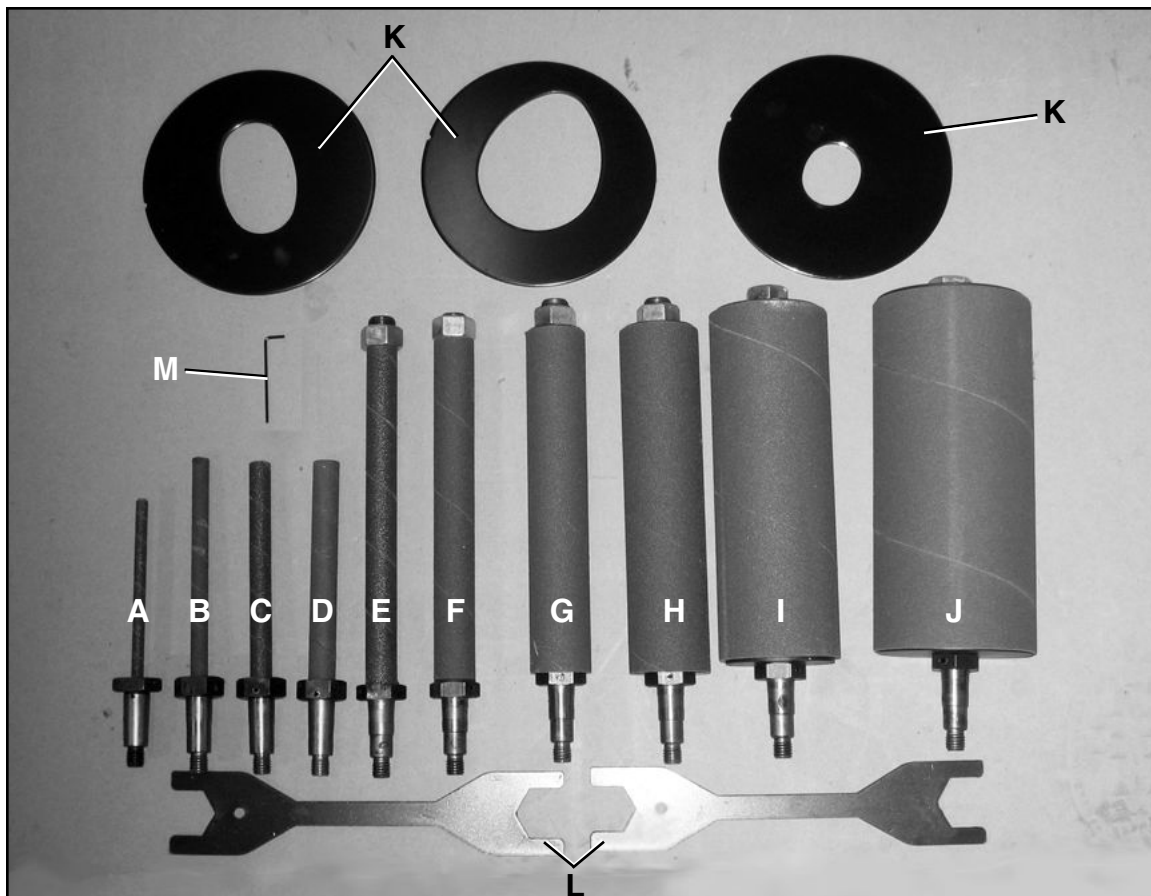

- A) 1/4" diameter spindle and sanding sleeve
- B) 3/8" diameter spindle and sanding sleeve
- C) 1/2" diameter spindle and sanding sleeve
- D) 5/8" diameter spindle and sanding sleeve
- E) 3/4" diameter spindle and sanding sleeve
- F) 1" diameter spindle and sanding sleeve
- G) 1-1/2" diameter spindle and sanding sleeve

- H) 2" diameter spindle and sanding sleeve
- I) 3" diameter spindle and sanding sleeve
- J) 4" diameter spindle and sanding sleeve
- K) Table insert rings (3)
- L) Spindle wrenches (2)
- M) 2mm hex wrench

ASSEMBLY

Assembly of the spindle sander is organized into steps. Please follow them in sequence. Review the parts diagrams and lists frequently to become familiar with all of the parts before you begin.

MOUNTING AND REMOVING SPINDLES

Spindle size should be based on needs of the project. Straight or gently curved surfaces will be best suited to the largest of the spindles. Tighter, more-intricate work-pieces will require the smaller spindles. Avoid the temptation to leave the same spindle on until its sanding sleeve wears out. You'll get much more life from each of your sanding spindles if they are used only for specific jobs.

The spindle sander comes equipped with two wrenches for spindle removal. They should be kept close to the machine for easy access. This model features two spindle trays which hold spindles in a handy location when they are not in use.

To install sanding spindles:

1. Pick out the appropriate spindle and remove it from the tray.
2. Drop the threaded end of the spindle into the spindle hole. Make sure the hole and the shaft are lightly greased.
3. Screw the spindle in by hand. Sanding action will further tighten the spindle so it is unnecessary to over-tighten.
4. The spindle is now mounted.

Fig. 1

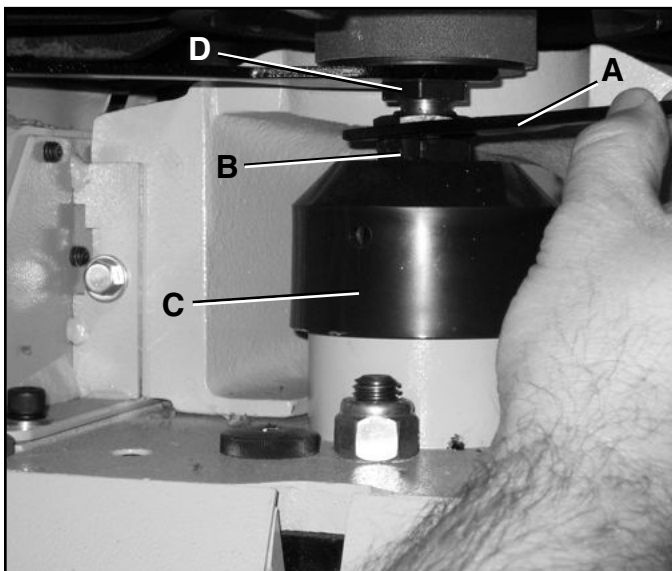

To remove the sanding spindle:

1. Use your spindle wrench (A) provided with the machine to hold the jam nuts (B) above the spindle cover (C) while loosening the spindle retainer nut (D) with another wrench. **SEE FIG. 1.**
2. Unscrew the sanding spindle and return it to the storage tray.

LUBRICATION

Check the gear oil level using the sight gage indicator which is located at the rear of the machine just below the dust port. This oil level should indicate full before the initial run of the machine. See "MAINTENANCE" section for more details on lubrication of the spindle sander. **SEE FIG. 2.**

Fig. 2



SELECTION GUIDE FOR DRUM TO TABLE INSERT

This machine is furnished with 10 drums. Range of drum diameter is 1/4" to 4". Three table inserts are supplied. If the drum diameter is changed, the table insert needs to be changed to the appropriate size.

⚠ WARNING

Failure to use the correct insert with the corresponding drum may result in injury!

TABLE INSERTS

The three inserts included with the spindle sander are sized to provide free sanding spindle movement while minimizing the gap between the abrasive surface and the table top. The holes in the inserts are shaped to allow the sanding spindles to rotate freely even when the table is aligned to its maximum 45° pitch.

Place the insert with the smallest diameter which allows free movement of the spindle over the top of the spindle and lower it into the hole in the table top. The insert is fitted with pins which only allow it to fit securely in one position on the table. That position allows the table to tilt without impeding the movement of the spindle.

Smooth movement of your workpiece is essential for proper sander operation. Make sure your inserts are aligned as closely to the table as possible. Refer to the chart below which indicates what insert to use with which spindle.

Spindle Size	Table Insert
#1 1/4" Dia. x 5" long	#1
#2 3/8" Dia. x 6" long	#1
#3 1/2" Dia. x 6" long	#1
#4 5/8" Dia. x 6" long	#1
#5 3/4" Dia. x 9" long	#1
#6 1" Dia. x 9" long	#2
#7 1-1/2" Dia. x 9" long	#2
#8 2" Dia. x 9" long	#3
#9 3" Dia. x 9" long	None
#10 4" Dia. x 9" long	None

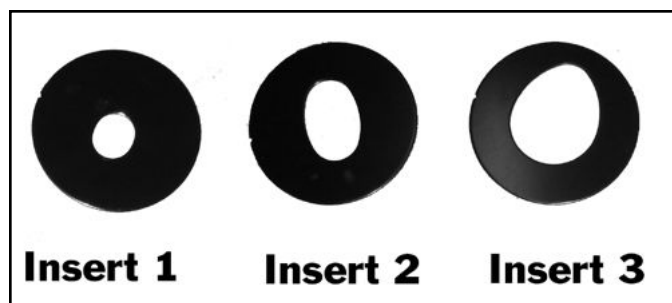

D. SANDING SLEEVES

To replace the sleeves:

1. Loosen the hex nut (A) at the top of the sanding spindle (B). SEE FIG. 3

Fig. 3

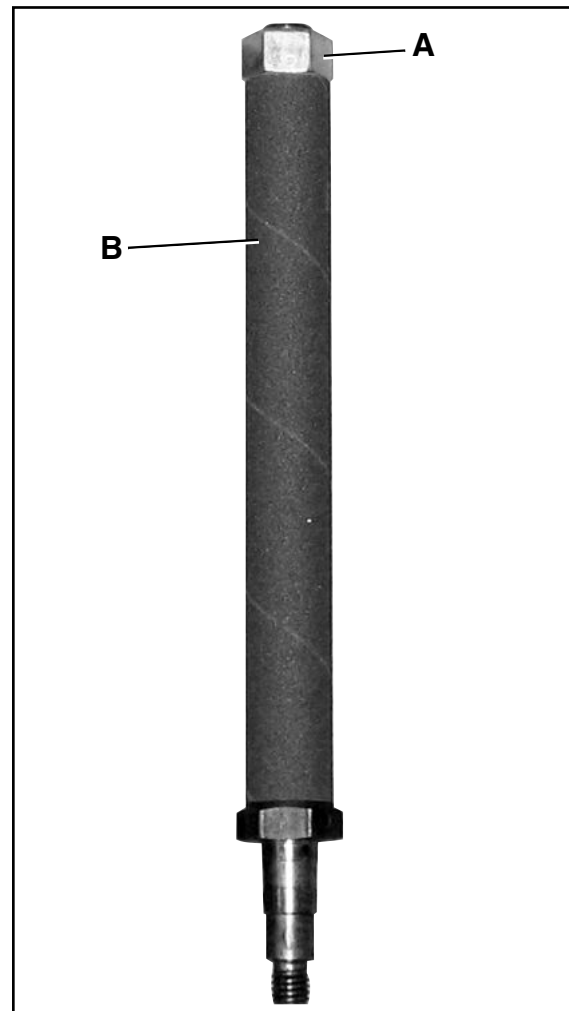

NOTE: Spindles 5/8" and smaller have set screws at their bases that secure the sleeves to the spindle.

2. Remove the sleeve from the spindle. If you have worn the sleeve out on one end, you can extend the life of the sleeve by flipping it over and refitting it on the spindle. If the entire sleeve is worn out, replace with a new sleeve of the correct diameter.
3. Re-tighten the hex nut at the top of the spindle (or setscrews at the base) and begin using again.

DUST COLLECTION

The spindle sander creates a large amount of dust while in use. It is strongly recommended that you connect the spindle sander to a dust collector. The exhaust hood is designed to accommodate 4" flexible collection hose.

ADJUSTMENTS

TABLE ANGLE

The angle adjustment knobs (A) enable the table top to be tilted up to 45°. Both knobs must be released to allow the table to tilt. The knobs are located under the table on both the left and right sides of the sander. The angle scale (B) shows the degree of pitch. SEE FIG. 4.

Fig. 4

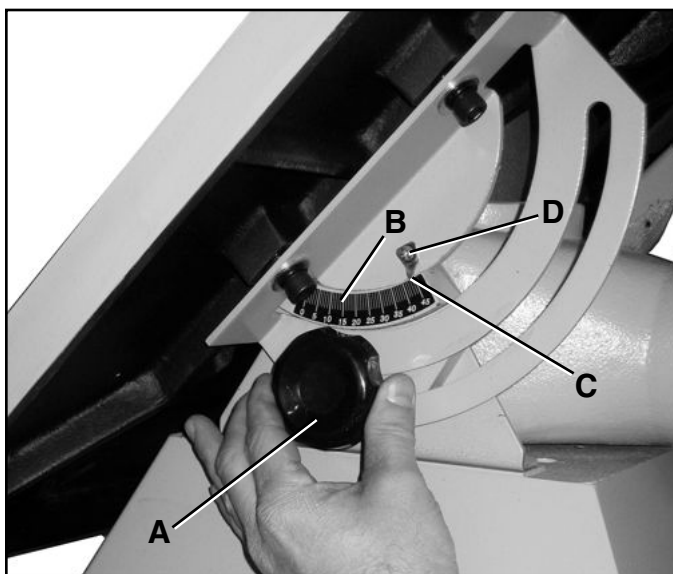

To calibrate the angle indicator:

1. Using a square, bring the table perpendicular (90°) to the spindle. Move the square around the sanding spindle to ensure that the table is square in all directions. SEE FIG. 5.

Fig. 5

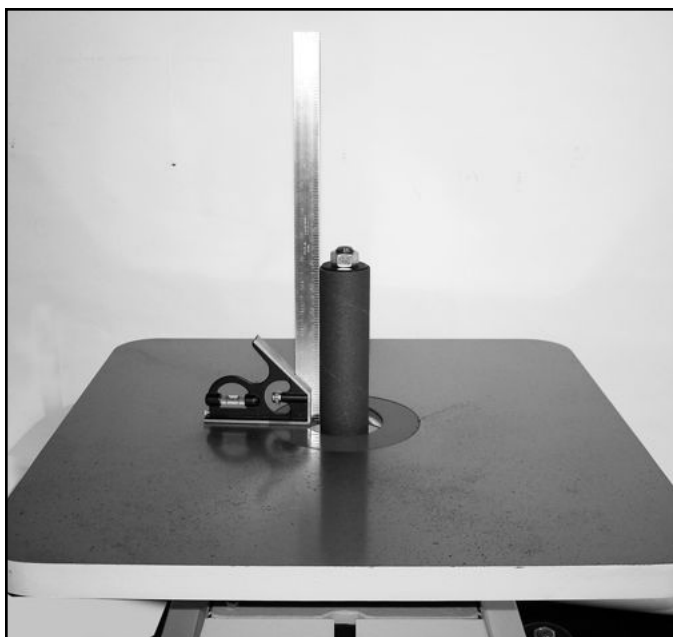

2. Lock the knobs down when your table is square to the sanding spindle. You can now calibrate the angle indicator arrow (C) by loosening its retaining screw (D) and turning the arrow until it points directly to "zero" on the angle guide. SEE FIG. 4.

There is a positive stop bolt (C) that, when adjusted correctly, allows you to return the table square to the spindle with little effort. The positive stop bolt is a long bolt located below the table. SEE FIG. 6.

Fig. 6

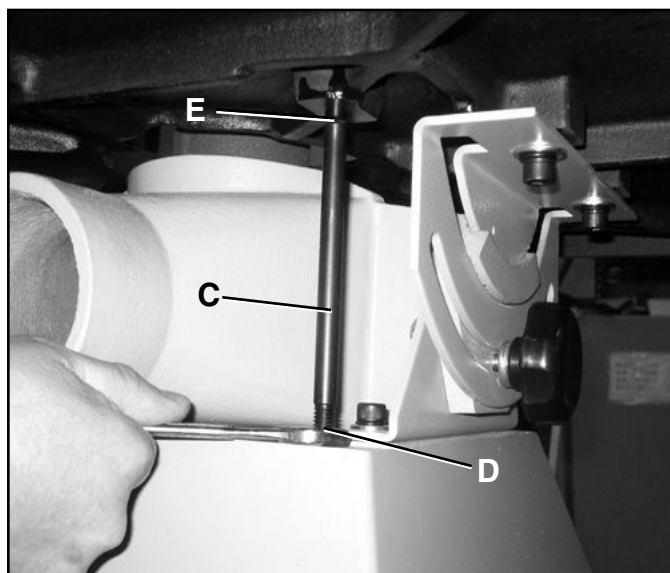

To adjust the positive stop bolt:

1. Loosen the jam nut (D) on the positive stop bolt using an open end wrench.
2. With the table square to the spindle and tightened securely, adjust the positive stop bolt so it just touches the table contact point (E).
3. Re-tighten the jam nut.

CHANGING MOTOR VOLTAGE

⚠ WARNING



MAKE CERTAIN THE MACHINE IS DISCONNECTED FROM THE POWER SOURCE.

The motor supplied with your sander is a dual voltage 115/230-volt, single-phase motor. It is shipped wired for 115-volt application. If you choose 230-volt to operate your machine, the following instructions must be followed.

⚠ WARNING

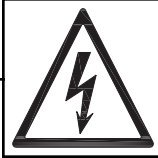

If you are unsure of electrical connections or codes, contact a certified electrician. All local and state codes must be followed.

Refer to “ELECTRICAL REQUIREMENTS” section before proceeding:

1. **DISCONNECT THE MACHINE FROM THE POWER SOURCE.**
2. Remove the switch box cover.
3. The motor has four leads. Reconnect the motor leads for chosen voltage, as shown in the wire diagram located on the inside of the motor junction box.
4. The START/STOP switch is a double pole switch. No changes are required for 115/230 volt operation.
5. Replace the plug with the correct plug with ground for voltage required. The new plug must meet all local and state electrical codes.
6. Reassemble switch box cover.

OPERATIONS

BEFORE STARTING YOUR SANDER FOR THE FIRST TIME, CHECK OIL LEVEL AND GREASE POINTS.

See “MAINTENANCE” section for more information. Check oil level at least once per month.

Also before starting the sander, be sure you have followed all the guidelines for set up. If everything checks out, push the START button and let the machine run. After a few moments, turn the machine off and use a piece of scrap wood to get a feel for the machine. As noted in the sander safety guidelines, make sure that any wood you use is free of defects and foreign objects.

FLAT SANDING

The spindle sander is designed to give clean finished edges to your work, so when pre-cutting with your jig saw or bandsaw, make a habit of cutting about 1/16” outside the edges of your finished workpiece.

1. Mark a clean line with a pencil or scribe along the desired outside edge of your workpiece, or in this case, your test piece.
2. When you’ve marked your material, turn the spindle sander on again. Let it reach its working speed and slide the test piece against the sanding surface. The sander requires little pressure between the spindle and workpiece.
3. Move your test piece against the rotation of the sanding spindle. To achieve the best results, remove excess material in several passes. Your results will be more even and you’ll have less chance of accidentally removing too much material or burning your work. Using this method will also decrease wear on your sanding sleeves. **SEE FIG. 7.**

Fig. 7



BEVEL SANDING

1. Tilt the table to the angle of bevel you desire.
2. Spin the sanding spindle by hand to ensure there is free movement. When beveling, always place your scribe marks at the outside (longest) edge of your bevel, so you can see the marks from above.
3. Start the machine and gently press the test piece against the sanding spindle. Take several passes until your scribe lines are reached. **SEE FIG. 8.**

Fig. 8



USING A FALSE TABLE

Using a 1” or thicker false table over the sander’s table will offer several advantages.

- It will raise the working surface up and make beveled sanding with the larger spindles easier.
- It will bring your working surface closer to the spindle for better control of smaller workpieces.
- It will allow you to more fully utilize the entire length of your sanding sleeves, especially when working with thin workpieces. The false table can be moved around on the sander’s table and secured by C-clamps.

MAINTENANCE

Your Spindle Sander requires very little maintenance. Cleaning will increase the machine's durability and efficiency by removing grime which can gum up moving parts. If you find that the machine sands less efficiently than usual, inspect the sanding sleeves and clean with a gum rubber belt cleaner or replace them as needed. An occasional application of good quality paste wax (one which does not contain silicone or other synthetics) will keep the sander table and other bare metal parts from rusting.

LUBRICATION

Bearings:

The Spindle Sander features factory-sealed bearings. A sealed bearing requires no lubrication during its lifetime.

Should a bearing fail, your spindle sander will probably develop a noticeable rumble, which will increase when the machine is put under load. Bearings must be replaced when this occurs.

Gear Oil:

Gear oil should be changed at 800 hours of use with a high-quality 90 Wt. SAE gear oil. The oil cap w/dipstick is located at the front of the machine, just below the table. The drain plug is at the base of the gear housing and is accessed through the door on the cabinet. The sander takes approximately 2 quarts. The oil level should be checked at least monthly and oil added when indicated by the dipstick.

Trunnions:

The trunnions should be lubricated with white lithium grease as needed to make table adjustment easier.

SANDING SLEEVE MAINTENANCE

Sanding sleeves should be inspected periodically for wear or damage. Damaged sleeves should be replaced before further use. Do not allow the rubber portion of the spindle to come in contact with workpieces during operation. Damage to the rubber will occur.

TROUBLESHOOTING GUIDE

TO PREVENT INJURY TO YOURSELF or damage to the spindle sander, turn the switch to the OFF position and unplug the power cord from the electrical receptacle before making any adjustments.

PROBLEM	LIKELY CAUSE(S)	SOLUTION
Motor will not start.	<ol style="list-style-type: none"> 1. Low or no voltage. 2. Open circuit in motor or loose connections. 	<ol style="list-style-type: none"> 1. Check power line for proper voltage. 2. Inspect all lead connections on motor for loose or open connections.
Motor will not start; fuses or circuit breakers blow.	<ol style="list-style-type: none"> 1. Short circuit in line cord or plug. 2. Short circuit in motor or loose connections. 3. Incorrect fuses or circuit breakers in power line. 	<ol style="list-style-type: none"> 1. Inspect cord or plug for damaged insulation and shorted wires. 2. Inspect all connections on motor for loose or shorted terminals or worn insulation. 3. Install correct fuses or circuit breakers.
Motor fails to develop full power (power output of motor decreases rapidly with decrease in voltage at motor terminals).	<ol style="list-style-type: none"> 1. Power line overloaded with lights, appliances, and other motors. 2. Undersized wires or circuits too long. 3. General overloading of power company facilities. 	<ol style="list-style-type: none"> 1. Reduce load on power line. 2. Increase wire sizes or reduce length of wire. 3. Request a power check from the power company.
Motor overheats.	<ol style="list-style-type: none"> 1. Motor overloaded. 2. Air circulation through the motor restricted. 	<ol style="list-style-type: none"> 1. Reduce load on motor. 2. Clean out motor to provide normal air circulation.
Motor stalls (resulting in blown fuses or tripped circuit).	<ol style="list-style-type: none"> 1. Short circuit in motor or loose connections. 2. Low voltage. 3. Incorrect fuses or circuit breakers in power line. 4. Motor overloaded. 	<ol style="list-style-type: none"> 1. Inspect connections on motor for loose or shorted terminals or worn insulation. 2. Correct the low voltage conditions. 3. Install correct fuses or circuit breakers. 4. Reduce load on motor.
Machine slows when operating.	<ol style="list-style-type: none"> 1. Applying too much pressure to workpiece. 	<ol style="list-style-type: none"> 1. Feed workpiece slower.
Spindle Collar rubs the edge of the table when tilted to 45°.	<ol style="list-style-type: none"> 1. Table slightly out of place. 	<ol style="list-style-type: none"> 1. Loosen the 4 bolts that mount the tables to the trunnions. Shift the table slightly to eliminate contact.
Sanding sleeve slips.	<ol style="list-style-type: none"> 1. Sleeve loose on spindle. 	<ol style="list-style-type: none"> 1. Tighten upper sanding sleeve nut.
Sanding sleeve burns the wood.	<ol style="list-style-type: none"> 1. Worn out sleeve. 	<ol style="list-style-type: none"> 1. Replace sleeve.

PARTS

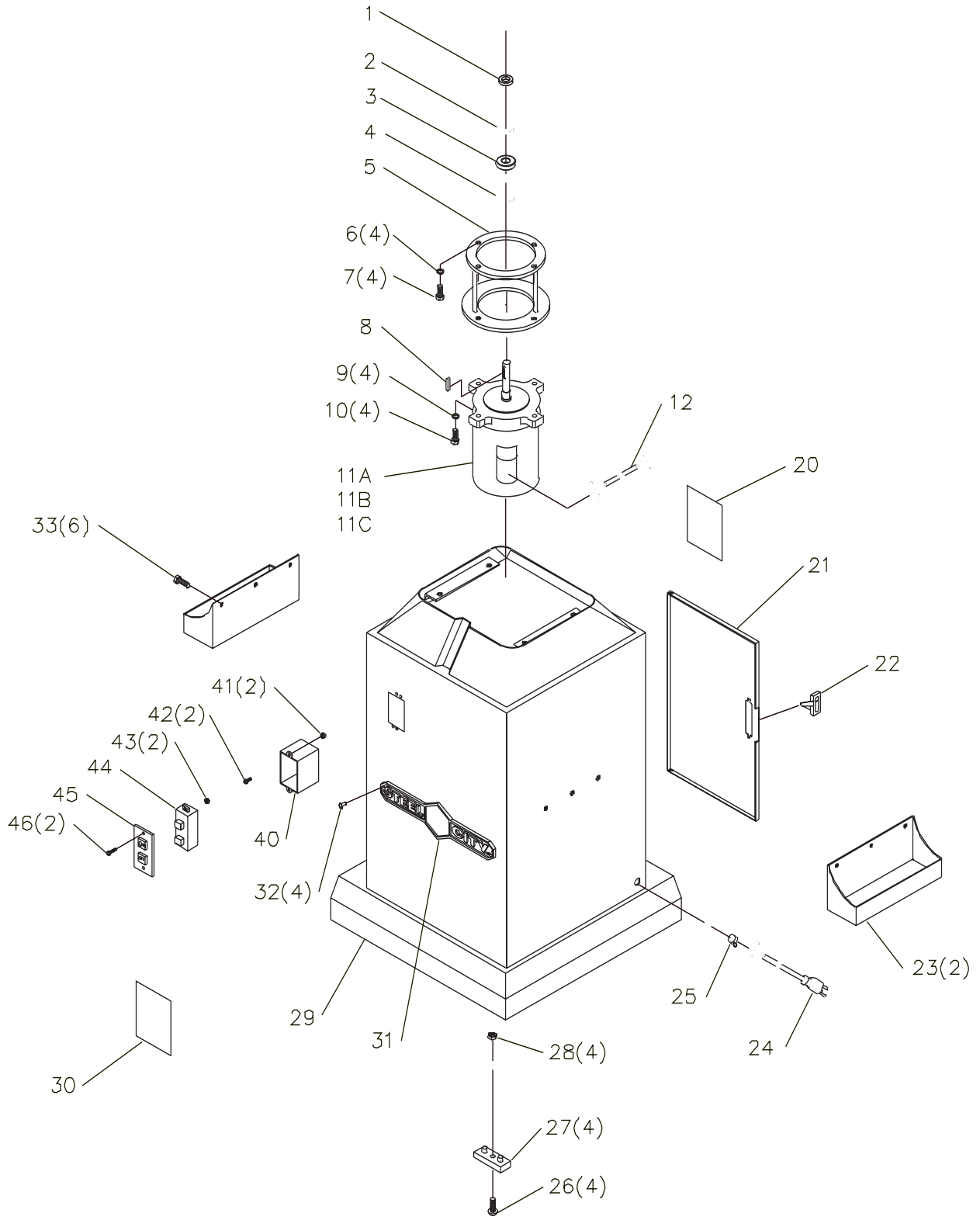

KEY NO.	PART NO.	DESCRIPTION	QTY.	KEY NO.	PART NO.	DESCRIPTION	QTY.
1	OR94117	Oil Seal	1	24	OR71165	Power Cord	1
2	OR94118	Retaining Ring	2	25	OR94125	Strain Relief Bushing	1
3	OR94119	Ball Bearing	1	26	OR94126	Pan Head Screw	4
4	OR94120	Retaining Ring	1	27	OR71166	Rubber Foot	4
5	OR71160	Motor Bracket	1	28	OR90616	5/16"-18 Hex Nut	4
6	OR94121	Lock Washer	4	29	OR71167	Base	1
7	OR94122	Hex Socket Head Cap Screw	4	30	OR71168	Safety Label	1
8	OR94123	Key	1	31	OR70484	Nameplate	1
9	OR94121	Lock Washer	4	32	OR93823	Rivet	4
10	OR94122	Hex Socket Head Cap Screw	4	33	OR94127	Hex Head Screw	6
11	OR71239	Motor Assembly (Consists of: 11A-12)	1	39	OR71238	Switch Assembly (Consists of: 40-46)	1
11A	OR70411	Motor	1	40	OR71168	Switch Box	1
11B	OR70360	Motor Spec Plate	1	41	OR90374	10-24 Hex Nut	2
11C	OR94124	Capacitor	1	42	OR94128	3/16"-24 x 5/8" Pan Head Screw	2
12	OR71161	Motor Cord	1	43	OR94129	Hex Nut	2
20	OR70301	Spec Plate	1	44	OR71169	Switch	1
21	OR71162	Rear Door	1	45	OR71170	Switch Panel	1
22	OR71163	Rear Door Latch	1	46	OR94130	Pan Head Screw	3
23	OR71164	Spindle Shelf	2				

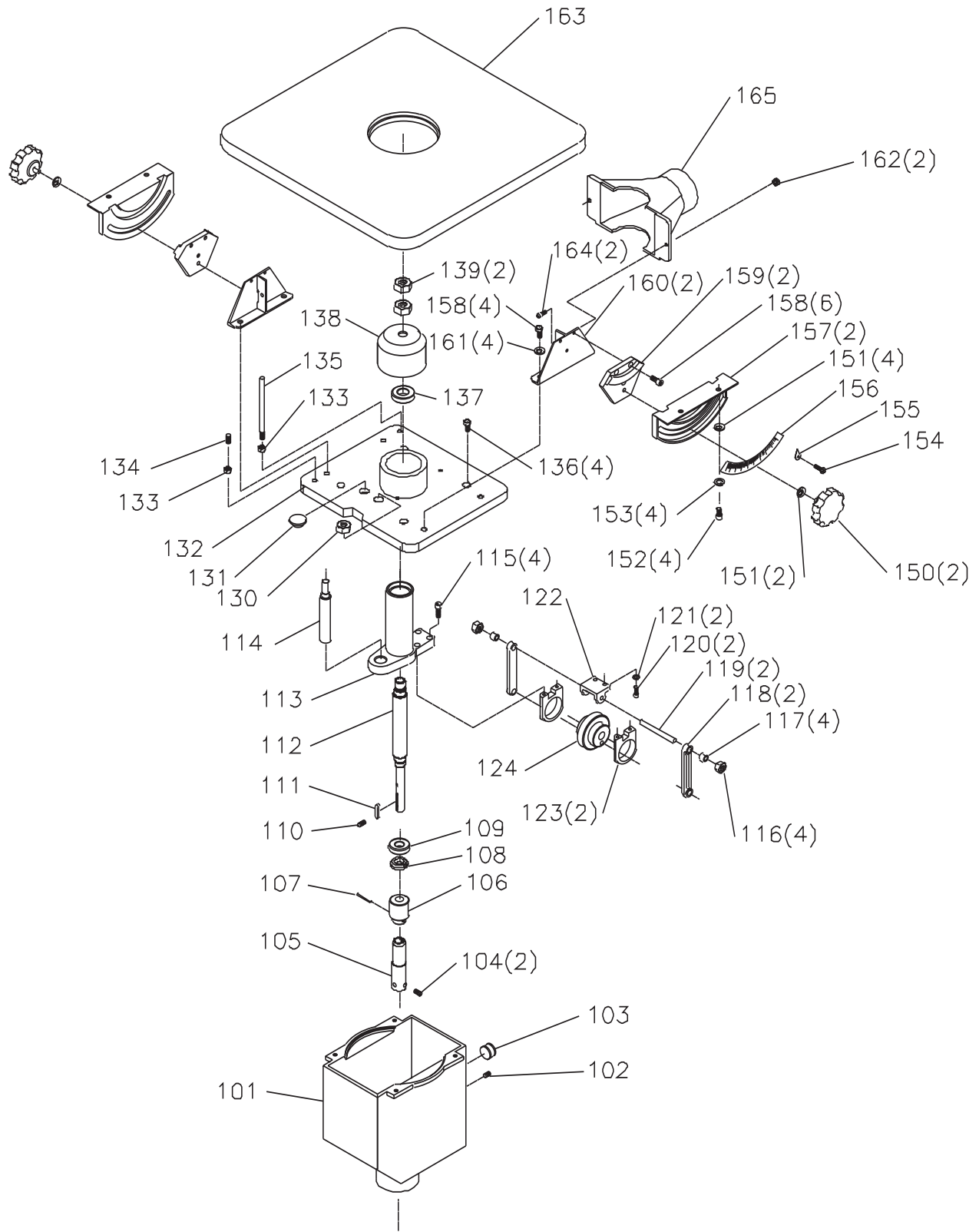

KEY NO.	PART NO.	DESCRIPTION	QTY.	KEY NO.	PART NO.	DESCRIPTION	QTY.
101	OR71171	Oil Tank	1	131	OR71185	Oil Cap	1
102	OR71172	Oil Plug	1	132	OR71186	Oil Tank Lid	1
103	OR71173	Oil Level Indicator	1	133	OR90369	3/8"-16 Hex Nut	2
104	OR94131	Set Screw	2	134	OR94139	3/8" -16 x 3/4" Hex Soc Hd Set Screw	1
105	OR71174	Shaft Coupler	1	135	OR71187	Table Tilt Rod	1
106	OR71175	Worm Gear	1	136	OR94122	Hex Socket Head Cap Screw	4
107	OR94132	Spring Pin	1	137	OR94140	Ball Bearing	1
108	OR94133	Lock Nut	1	138	OR71188	Cap	1
109	OR94134	Ball Bearing	1	139	OR94141	Nut	2
110	OR94135	M3 x 12mm Hex Socket Head Cap Screw	2	150	OR71189	Lock Knob	2
111	OR94136	Key	1	151	OR90467	3/8" Flat Washer	8
112	OR71176	Main Shaft	1	152	OR94142	Hex Socket Head Cap Screw	4
113	OR71177	Spindle Sleeve Bracket	1	153	OR90647	3/8" Lock Washer	4
114	OR71178	Guide Rail Shaft	1	154	OR94143	Screw	1
115	OR94122	Hex Socket Head Cap Screw	4	155	OR71190	Pointer	1
116	OR94137	3"-16 Nylok	4	156	OR71191	Scale	1
117	OR71179	Bushing	4	157	OR71192	Trunnion	2
118	OR71180	Transmission Rod	2	158	OR93868	5/16"-18 x 1/2" Hex Head Screw	10
119	OR71181	Transmission Rod Shaft	2	159	OR71193	Trunnion Bracket	2
120	OR94122	Hex Socket Head Cap Screw	2	160	OR71194	Bracket	2
121	OR94121	Lock Washer	2	161	OR94145	Washer	4
122	OR71182	Bracket	1	162	OR90616	5/16"-18 Hex Nut	2
123	OR71183	Gear Yoke	2	163	OR71195	Table	1
124	OR71184	Spur Gear	1	164	OR94144	5/16"-18 x 5/8 Hex Socket Head Cap Screw	2
130	OR94138	Lock Nut	1	165	OR71196	Dust Chute	1

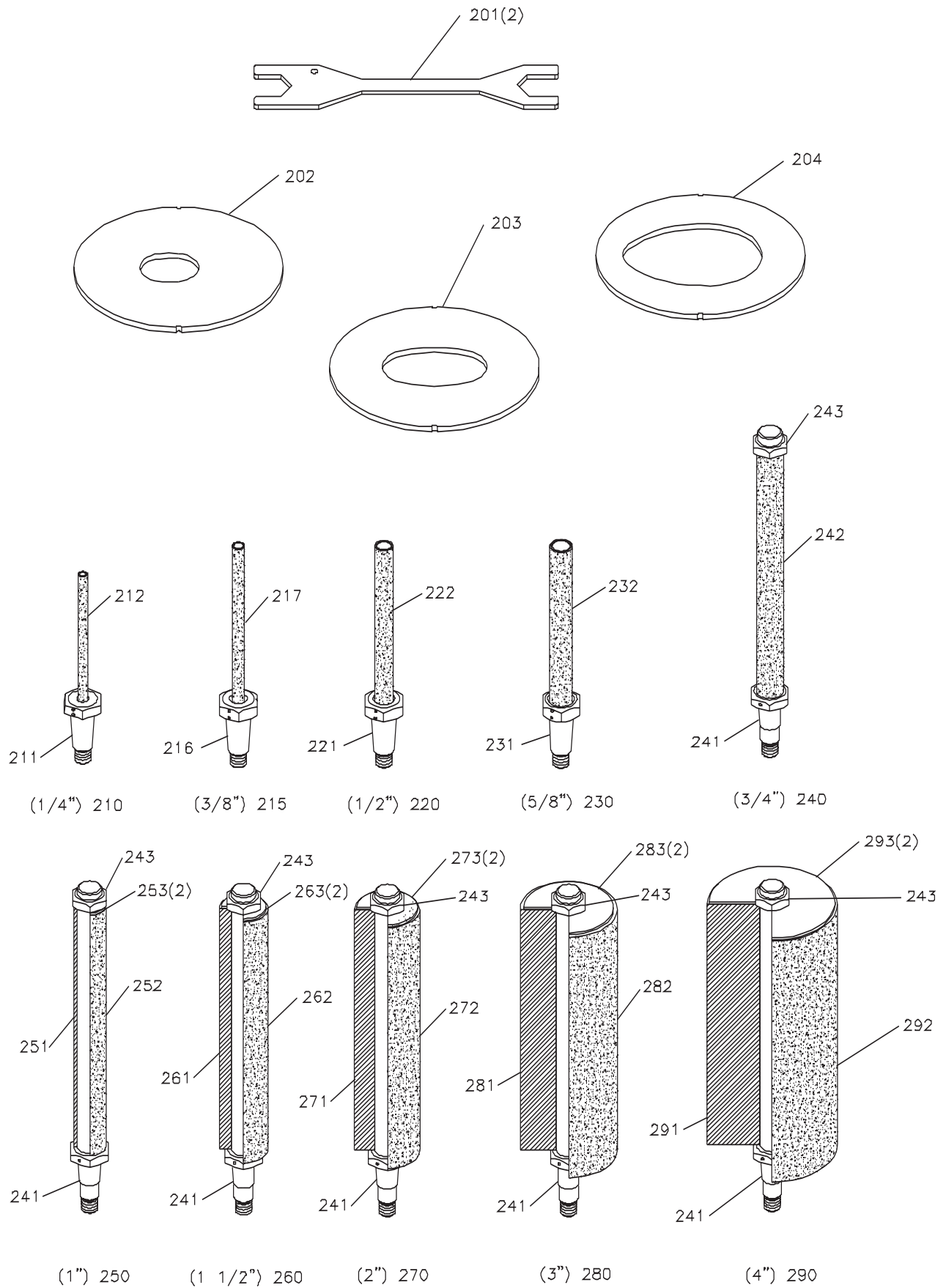

KEY NO.	PART NO.	DESCRIPTION	QTY.	KEY NO.	PART NO.	DESCRIPTION	QTY.
201	OR94146	Wrench	2	253	OR71218	1" Washer	2
202	OR71197	Table Insert (small)	1	260	OR71219	1 1/2" Spindle Assy Const. Of Ref 241, 261, 262, 263, 243	1
203	OR71198	Table Insert (medium)	1	261	OR71220	1-1/2" Rubber Drum	1
204	OR71199	Table Insert (Large)	1	262	OR71221	1 1/2" Sand Paper	1
210	OR71200	1/4" Spindle Assy Const. Of Ref 211, 212	1	263	OR71222	1 -1/2" Washer	2
211	OR71201	1/4" Spindle	1	270	OR71223	2" Spindle Assy Const. Of Ref 241, 271, 272, 273, 243	1
212	OR71202	1/4" Sand Paper	1	271	OR71224	2" Rubber Drum	1
215	OR71203	3/8" Spindle Assy Const. Of Ref 216, 217	1	272	OR71225	2" Sand Paper	1
216	OR71204	3/8" Spindle	1	273	OR71226	2" Washer	2
217	OR71205	3/8" Sand Paper	1	280	OR71227	3" Spindle Assy Const. Of Ref 241, 281, 282, 283, 243	1
220	OR71206	1/2" Spindle Assy Const. Of Ref 221, 222	1	281	OR71228	3" Rubber Drum	1
221	OR71207	1/2" Spindle	1	282	OR71229	3" Sand Paper	1
222	OR71208	1/2" Sand Paper	1	283	OR71230	3" Washer	2
230	OR71209	5/8" Spindle Assy Const. Of Ref 231, 232	1	290	OR71231	4" Spindle Assy Const. Of Ref 241, 291, 292, 293, 243	1
231	OR71210	5/8" Spindle	1	291	OR71232	4" Rubber Drum	1
232	OR71211	5/8" Sand Paper	1	292	OR71233	4" Sand Paper	1
240	OR71212	3/4" Spindle Assy Const. Of Ref 241, 242, 243	1	293	OR71234	4" Washer	2
241	OR71213	3/4" Spindle	6	300	OR71235	Manual (Not Shown)	1
242	OR71214	3/4" Sand Paper	1	301	OR71236	Manual French (Not Shown)	1
243	OR94147	3/4" Hex Nut	6	302	OR71237	Manual Spanish (Not Shown)	1
250	OR71215	1" Spindle Assy Const. Of Ref 241, 251, 252, 253, 243	1				
251	OR71216	1" Rubber Drum	1				
252	OR71217	1" Sand Paper	1				

◆ NOTES ◆

◆ NOTES ◆

◆ NOTES ◆



STEEL CITY TOOL WORKS

www.steelcitytoolworks.com

1-877-SC4-TOOL

(1-877-724-8665)

5 Year Warranty

