



User Manual

Read and understand this manual before using machine.

AIR CLEANER – SINGLE SPEED



**Model Number
65100**



STEEL CITY TOOL WORKS

Manual Part No. OR70251



THANK YOU for purchasing your new Steel City Air Cleaner. This air cleaner has been designed, tested, and inspected with you, the customer, in mind. When properly used and maintained, your air cleaner will provide you with years of trouble free service, which is why it is backed by one of the longest machinery warranties in the business.

This air cleaner is just one of many products in the Steel City's family of woodworking machinery and is proof of our commitment to total customer satisfaction.

At Steel City we continue to strive for excellence each and every day and value the opinion of you, our customer. For comments about your air cleaner or Steel City Tool Works, please visit our web site at www.steelcitytoolworks.com .

TABLE OF CONTENTS

INTRODUCTION

SECTION 1	Warranty	4
SECTION 2	Product Specifications	7
SECTION 3	Accessories and Attachments	7
SECTION 4	Definition of Terms	7
SECTION 5	Feature Identification	8
SECTION 6	General Safety	9
SECTION 7	Product Safety	11
SECTION 8	Electrical Requirements	12
SECTION 9	Unpacking & Inventory	14
SECTION 10	Assembly	15
SECTION 11	Operations	16
SECTION 12	Maintenance	17
SECTION 13	Troubleshooting	18
SECTION 14	Parts List	20-21

INTRODUCTION

This user manual is intended for use by anyone working with this machine. It should be kept available for immediate reference so that all operations can be performed with maximum efficiency and safety. Do not attempt to perform maintenance or operate this machine until you have read and understand the information contained in this manual.

This Air Cleaner is intended to filter dry airborne wood dust only. It must be limited to non-explosive, non-metallic atmosphere. This machine is not to be modified for any reasons.

The drawings, illustrations, photographs, and specifications in this user manual represent your machine at time of print. However, changes may be made to your machine or this manual at any time with no obligation to Steel City Tool Works.

WARRANTY

STEEL CITY TOOL WORKS 5 YEAR LIMITED WARRANTY

Steel City Tool Works, LLC (“SCTW”) warrants all “STEEL CITY TOOL WORKS” machinery to be free of defects in workmanship and materials for a period of 5 years from the date of the original retail purchase by the original owner. SCTW will repair or replace, at its expense and at its option, any SCTW machine, machine part, or machine accessory which in normal use has proven to be defective, provided that the customer returns the product, shipping prepaid, to an authorized service center with proof of purchase and provides SCTW with a reasonable opportunity to verify the alleged defect by inspection. This warranty does not apply to defects due directly or indirectly to misuse, abuse, negligence, accidents, or lack of maintenance, or to repairs or alterations made or specifically authorized by anyone other than SCTW. Normal wear components are also excluded under this coverage. Every effort has been made to ensure that all SCTW machinery meets the highest quality and durability standards. We reserve the right to change specifications at any time due to our commitment to continuous improvement of the quality of our products.

EXCEPT AS SET FORTH ABOVE, SCTW MAKES NO EXPRESS OR IMPLIED REPRESENTATIONS OR WARRANTIES WITH RESPECT TO ITS MACHINERY, OR ITS CONDITION, MERCHANTABILITY, OR FITNESS FOR ANY PARTICULAR PURPOSE OR USE. SCTW FURNISHES THE ABOVE WARRANTIES IN LIEU OF ALL OTHER WARRANTIES, EXPRESS OR IMPLIED, INCLUDING THE WARRANTIES OF MERCHANTABILITY AND FITNESS FOR A PARTICULAR PURPOSE, WHICH ARE HEREBY SPECIFICALLY DISCLAIMED.

SCTW SHALL NOT BE LIABLE FOR ANY (A) SPECIAL, INDIRECT, INCIDENTAL, PUNITIVE OR CONSEQUENTIAL DAMAGES, INCLUDING WITHOUT LIMITATION LOSS OF PROFITS, ARISING FROM OR RELATED TO THIS WARRANTY, THE BREACH OF ANY AGREEMENT OR WARRANTY, OR THE OPERATION OR USE OF ITS MACHINERY, INCLUDING WITHOUT LIMITATION DAMAGES ARISING FROM DAMAGE TO FIXTURES, TOOLS, EQUIPMENT, PARTS OR MATERIALS, DIRECT OR INDIRECT LOSS CAUSED BY ANY OTHER PARTY, LOSS OF REVENUE OR PROFITS, FINANCING OR INTEREST CHARGES, AND CLAIMS BY ANY THIRD PERSON, WHETHER OR NOT NOTICE OF SUCH POSSIBLE DAMAGES HAS BEEN GIVEN TO SCTW; (B) DAMAGES OF ANY KIND FOR ANY DELAY BY OR FAILURE OF SCTW TO PERFORM ITS OBLIGATIONS UNDER THIS AGREEMENT; OR (C) CLAIMS MADE A SUBJECT OF A LEGAL PROCEEDING AGAINST SCTW MORE THAN ONE (1) YEAR AFTER SUCH CAUSE OF ACTION FIRST AROSE.

The validity, construction and performance of this Warranty and any sale of machinery by SCTW shall be governed by the laws of the Commonwealth of Pennsylvania, without regard to conflicts of laws provisions of any jurisdiction. Any action related in any way to any alleged or actual offer, acceptance or sale by SCTW, or any claim related to the performance of any agreement including without limitation this Warranty, shall take place in the federal or state courts in Allegheny County, Pennsylvania.

STEEL CITY TOOL WORKS

WARRANTY CARD

Name _____
 Street _____
 Apt. No. _____
 City _____ State _____ Zip _____
 Phone Number _____
 E-Mail _____

Product Description: _____
 Model No.: _____
 Serial No. _____

The following information is given on a voluntary basis and is strictly confidential.

1. Where did you purchase your STEEL CITY machine?
 Store: _____
 City: _____

2. How did you first learn of Steel City Tool Works?
 Advertisement Mail Order Catalog
 Web Site Friend
 Local Store Other _____

3. Which of the following magazines do you subscribe to?
 American Woodworker American How-To
 Cabinetmaker Family Handyman
 Fine Homebuilding Fine Woodworking
 Journal of Light Construction Old House Journal
 Popular Mechanics Popular Science
 Popular Woodworking Today's Homeowner
 WOOD Woodcraft
 WOODEN Boat Woodshop News
 Woodsmith Woodwork
 Woodworker Woodworker's Journal
 Workbench Other _____

4. Which of the following woodworking / remodeling shows do you watch?
 Backyard America The American Woodworker
 Home Time The New Yankee Workshop
 This Old House Woodwright's Shop
 Other _____

5. What is your annual household income?
 \$20,000 to \$29,999 \$30,000 to \$39,999
 \$40,000 to \$49,999 \$50,000 to \$59,999
 \$60,000 to \$69,999 70,000 to \$79,999
 \$80,000 to \$89,999 \$90,000 +

6. What is your age group?
 20 to 29 years 30 to 39 years
 40 to 49 years 50 to 59 years
 60 to 69 years 70 + years

7. How long have you been a woodworker?
 0 to 2 years 2 to 8 years
 8 to 20 years over 20 years

8. How would you rank your woodworking skills?
 Simple Intermediate
 Advance Master Craftsman

9. How many Steel City machines do you own? _____

10. What stationary woodworking tools do you own?
Check all that apply.
 Air Compressor Band Saw
 Drill Press Drum Sander
 Dust Collection Horizontal Boring Machine
 Jointer Lathe
 Mortiser Panel Saw
 Planer Power Feeder
 Radial Arm Saw Shaper
 Spindle Sander Table Saw
 Vacuum Veneer Press Wide Belt Sander
 Other _____

11. Which benchtop tools do you own? *Check all that apply.*
 Belt Sander Belt / Disc Sander
 Drill Press Band Saw
 Grinder Mini Jointer
 Mini Lathe Scroll Saw
 Spindle / Belt Sander Other _____

12. Which portable / hand held power tools do you own?
Check all that apply.
 Belt Sander Biscuit Jointer
 Dust Collector Circular Saw
 Detail Sander Drill / Driver
 Miter Saw Orbital Sander
 Palm Sander Portable Thickness Planer
 Saber Saw Reciprocating Saw
 Router Other _____

13. What machines / accessories would you like to see added to the STEEL CITY line?

14. What new accessories would you like to see added?

15. Do you think your purchase represents good value?
 Yes No

16. Would you recommend STEEL CITY products to a friend?
 Yes No

17. Comments:

CUT HERE

FOLD ON DOTTED LINE

PLACE
STAMP
HERE

Steel City Tool Works
P.O. Box 10529
Murfreesboro, TN 37129

FOLD ON DOTTED LINE

PRODUCT SPECIFICATIONS

Motor Specifications:

Type	Induction, Ball Bearing
Continuous Duty	
Horsepower	1/8
Amps	2.3
Voltage	120
Phase	Single
Hertz	60
RPM	1180 (no load)

Product Specifications:

Noise Level (Decibel)	66 dB
CFM	850
Outer Filter	5 micron, electrostatic
Inner Filter	1 micron
Filter Cycle (20' x 20' x 8')	16 times per hour

Product Dimensions:

Footprint	28" x 24" (71cm x 61cm)
Length	28" (71cm)
Width	24" (61cm)
Height	12" (30.5cm)
Weight	55 Lbs. (25Kg)

Shipping Dimensions:

Carton Type	Cardboard
Length	30-3/8" (77cm)
Width	26" (66cm)
Height	14.2 (36cm)
Gross Weight	68.2 Lbs. (31Kg)

ACCESSORIES AND ATTACHMENTS

WARNING

Use only accessories recommended for this machine. Using other accessories may cause serious injury and cause damage to the machine.

Contact your local Steel City dealer for accessories, or visit our website at: www.steelcitytoolworks.com.

DEFINITION OF TERMS

Below are some terms that will help you to understand and setup your Air Cleaner and design your own Air Cleaner System.

Air Cleaner or Ambient Air Cleaner – A machine used to filter dry airborne wood dust.

Dust Collector – A machine used to collect fine wood dust and chips.

Dust Collection System – A dust collector connected to multiple woodworking machines utilizing various types of hose/pipe and fittings.

C.F.M. = Cubic Feet/Minute – A measurement of the amount of air volume that can move through a dust collector in one minute.

Static Pressure – A measurement of the amount of the resistance to airflow in a dust collection system.

One Micron – One micron is equal to one millionth of a meter.

FEATURE IDENTIFICATION

Fig. 1-1

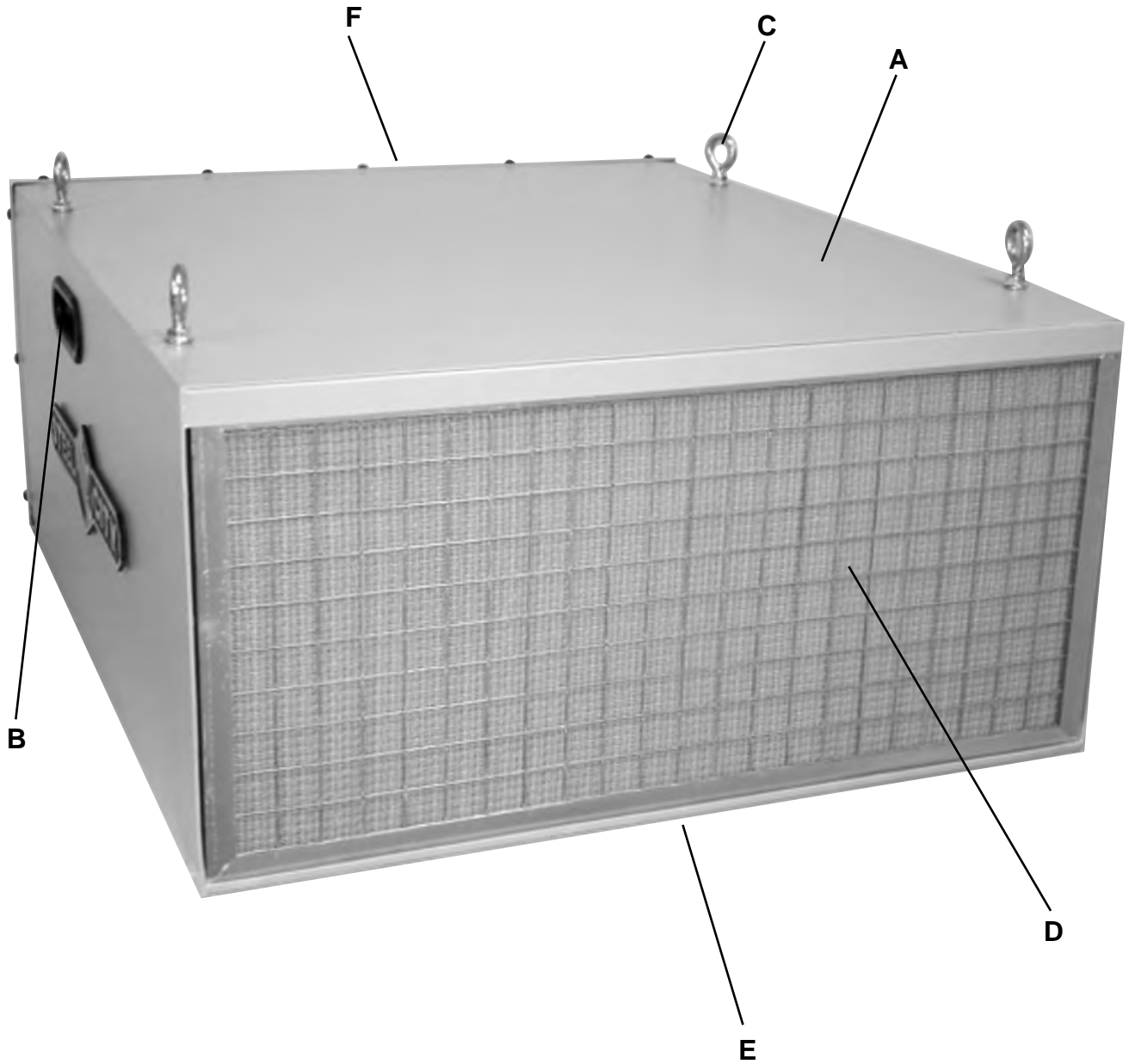

- A. Air Cleaner
- B. Handle
- C. Eye-bolt
- D. Electrostatic Filter
- E. Intake Side
- F. Exhaust Side

GENERAL SAFETY

⚠ WARNING

TO AVOID serious injury and damage to the machine, read and follow all Safety and Operating Instructions before assembling and operating this machine.

This manual is not totally comprehensive. It does not and can not convey every possible safety and operational problem which may arise while using this machine. The manual will cover many of the basic and specific safety procedures needed in an industrial environment.

All federal and state laws and any regulations having jurisdiction covering the safety requirements for use of this machine take precedence over the statements in this manual. Users of this machine must adhere to all such regulations.

Below is a list of symbols that are used to attract your attention to possible dangerous conditions.



This is the safety alert symbol. It is used to alert you to potential personal injury hazards. Obey all safety messages that follow this symbol to avoid possible injury or death.

⚠ DANGER

Indicates an imminently hazardous situation which, if not avoided, **WILL** result in death or serious injury.

⚠ WARNING

Indicates a potentially hazardous situation which, if not avoided, **COULD** result in death or serious injury.

⚠ CAUTION

Indicates a potentially hazardous situation, if not avoided, **MAY** result in minor or moderate injury. It may also be used to alert against unsafe practices.

CAUTION

CAUTION used without the safety alert symbol indicates a potentially hazardous situation which, if not avoided, may result in property damage.

NOTICE

This symbol is used to alert the user to useful information about proper operation of the machine.

⚠ WARNING

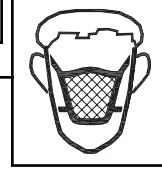

Exposure to the dust created by power sanding, sawing, grinding, drilling and other construction activities may cause serious and permanent respiratory or other injury, including silicosis (a serious lung disease), cancer, and death. Avoid breathing the dust, and avoid prolonged contact with dust. The dust may contain chemicals known to the State of California to cause cancer, birth defects or other reproductive harm.

Some examples of these chemicals are:

- Lead from lead-based paints.
- Crystalline silica from bricks, cement and other masonry products.
- Arsenic and chromium from chemically-treated lumber.

Always operate tool in well ventilated area and provide for proper dust removal. Use a dust collection system along with an air filtration system whenever possible. Always use properly fitting NIOSH/OSHA approved respiratory protection appropriate for the dust exposure, and wash exposed areas with soap and water.

1. To avoid serious injury and damage to the machine, read the entire User Manual before assembly and operation of this machine.

⚠ WARNING

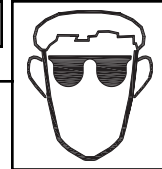

2. **ALWAYS** wear eye protection. Any machine can throw debris into the eyes during operations, which could cause severe and permanent eye damage. Everyday eyeglasses are **NOT** safety glasses. **ALWAYS** wear Safety Goggles (that comply with ANSI standard Z87.1) when operating power tools.

▲ WARNING

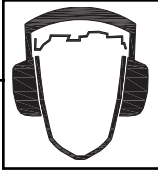

3. **ALWAYS** wear hearing protection. Plain cotton is not an acceptable protective device. Hearing equipment should comply with ANSI S3.19 Standards.

▲ WARNING

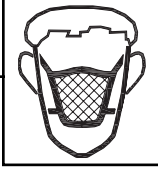

4. **ALWAYS** wear a NIOSH/OSHA approved dust mask to prevent inhaling dangerous dust or airborne particles.

5. **ALWAYS** keep the work area clean, well lit, and organized. **DO NOT** work in an area that has slippery floor surfaces from debris, grease, and wax.
6. **ALWAYS** unplug the machine from the electrical receptacle when making adjustments, changing parts or performing any maintenance.
7. **DO NOT** leave the air cleaner plugged into the electrical outlet. Unplug air cleaner from the outlet when not in use and before servicing, changing filters, unclogging and cleaning.
8. **DO NOT** use this unit to filter metal dust. Combining wood and metal dust can create an explosion or fire hazard. This air cleaner is intended for use where only dry airborne dust is present. Its use should be limited to non-explosive, non-metallic atmospheres.
9. **DO NOT** use this machine to dissipate fumes or smoke; fire or explosions can result.

10. **SECURELY** anchor this unit into a supporting structure when suspending it from the ceiling. Always keep a minimum of 7 feet between the bottom of the unit and the floor surface to allow for sufficient head clearance. Use only a chain rated for a minimum of 150 lb. working load to adequately hold the unit. Use steel S-hooks that are at least 1/4" in diameter to suspend the unit from the ceiling. Lag-type bolts used to suspend the unit from the ceiling must be threaded at least 1-1/2" into the supporting structural members.
11. **SUPPORT** this unit or securely clamp it to the work surface when it is used in a portable application to eliminate potential movement and/or damage from falling.
12. **DO NOT** operate this unit without the filters in place.
13. **MAKE CERTAIN** that the intake and exhaust areas are clean prior to starting the unit. A clogged intake or exhaust can cause a fire and/or explosion.

▲ WARNING

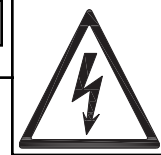

14. **KEEP** all fingers, arms, and hands away from the fan. Avoid all exposure to rotating parts to prevent injury.

▲ WARNING

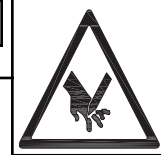

15. **DO NOT** handle the plug or air cleaner with wet hands.
16. **DO NOT** pull the air cleaner by the power cord. **NEVER** allow the power cord to come in contact with sharp edges, hot surfaces, oil or grease.

PRODUCT SAFETY

1. Serious personal injury may occur if normal safety precautions are overlooked or ignored. Accidents are frequently caused by lack of familiarity or failure to pay attention. Obtain advice from supervisor, instructor, or another qualified individual who is familiar with this machine and its operations.
2. Every work area is different. Always consider safety first, as it applies to your work area. Use this machine with respect and caution. Failure to do so could result in serious personal injury and damage to the machine.
3. Prevent electrical shock. Follow all electrical and safety codes, including the National Electrical Code (NEC) and the Occupational Safety and Health Regulations (OSHA). All electrical connections and wiring should be made by qualified personnel only.

▲ WARNING



4. **TO REDUCE** the risk of electrical shock. **DO NOT** use this machine outdoors. **DO NOT** expose to rain. Store indoors in a dry area.

5. **STOP** using this machine, if at any time you experience difficulties in performing any operation. Contact your supervisor, instructor or machine service center immediately.
6. Safety decals are on this machine to warn and direct you to how to protect yourself or visitors from personal injury. These decals **MUST** be maintained so that they are legible. **REPLACE** decals that are not legible.
7. **DO NOT** leave the air cleaner plugged into the electrical outlet. Unplug air cleaner from the outlet when not in use and before servicing, changing bags, unclogging and cleaning.
8. **ALWAYS** turn the power switch "OFF" before unplugging the air cleaner.

▲ WARNING

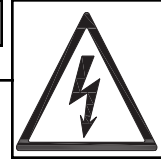

9. **DO NOT** handle the plug or air cleaner with wet hands.

10. **NEVER** use the air cleaner near any flammable or combustible liquids.
11. **NEVER** use the air cleaner to dissipate fumes or smoke. **NEVER** pick up anything that is burning or smoking, such as cigarettes, matches or hot ashes.
12. **USE** only as described in this manual. **USE** accessories only recommended by Steel City.
13. **DO NOT** pull the air cleaner by the power cord. **NEVER** allow the power cord to come in contact with sharp edges, hot surfaces, oil or grease.
14. **REPLACE** a damaged cord immediately. **DO NOT** use a damaged cord or plug. If the air cleaner is not operating properly, or has been damaged, left outdoors or has been in contact with water.
15. **DO NOT** use the air cleaner as a toy. **DO NOT** use near or around children.

▲ WARNING

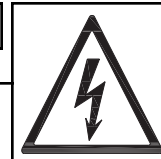

16. **DO NOT** insert fingers or foreign objects into the dust intake port. Keep hair, loose clothing, fingers, and all body parts away from openings and moving parts of the air cleaner.

17. **PERIODICALLY INSPECT** filter for any cuts, rips or tears. **NEVER** operate the air cleaner with a damaged filter.
18. The air cleaner is designed for home use or light commercial duty **ONLY**.
19. **CONNECT** air cleaner to a properly grounded outlet only. See grounding instructions.

ELECTRICAL REQUIREMENTS

⚠ WARNING

TO PREVENT electrical shock, follow all electrical and safety codes, including the National Electrical Code (NEC) and the Occupational Safety and Health Regulations (OSHA). All electrical connections and wiring should be made by qualified personnel only.

TO REDUCE the risk of electrical shock, **DO NOT** use machine outdoors. **DO NOT** expose to rain. Store indoors in a dry area.

DO NOT connect the machine to the power source before you have completed the set up process. **DO NOT** connect the machine to the power source until instructed to do so.

GROUNDING INSTRUCTIONS

⚠ WARNING



This machine **MUST BE GROUNDED** while in use to protect the operator from electric shock.

In the event of a malfunction or breakdown, **GROUNDING** provides the path of least resistance for electric current and reduces the risk of electric shock. This machine is equipped with an electric cord that has an equipment-grounding conductor and a grounding plug. The plug **MUST** be plugged into a matching electrical receptacle that is properly installed and grounded in accordance with **ALL** local codes and ordinances.

If a plug is provided with your machine **DO NOT** modify the plug. If it will not fit your electrical receptacle, have a qualified electrician install the proper connections to meet all electrical codes local and state. All connections must also adhere to all of OSHA mandates.

IMPROPER ELECTRICAL CONNECTION of the equipment-grounding conductor can result in risk of electric shock. The conductor with the green insulation (with or without yellow stripes) is the equipment-grounding conductor. **DO NOT** connect the equipment-grounding conductor to a live terminal if repair or replacement of the electric cord or plug is necessary.

Check with a qualified electrician or service personnel if you do not completely understand the grounding instructions, or if you are not sure the tool is properly grounded.

PLUGS/RECEPTACLES

⚠ WARNING

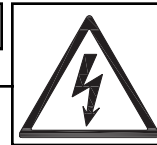

- Electrocutation or fire could result if this machine is not grounded properly or if the electrical configuration does not comply with local and state electrical codes.
- **MAKE CERTAIN** the machine is disconnected from power source before starting any electrical work.
- **MAKE SURE** the circuit breaker does not exceed the rating of the plug and receptacle.

The motor supplied with your machine is a 120 volt, alternating current, 60 hertz, single phase motor. It is shipped wired for 120 volt application. Never connect the green or ground wire to a live terminal.

This tool is intended for use on a circuit that has an electrical receptacle as shown in Figure 1-1. Figure 1-1 shows a NEMA approved 3-wire, 15 amp electrical plug and receptacle that have a grounding conductor. If a properly grounded electrical receptacle is not available, an adapter as shown in Figure 1-2 can be used to temporarily connect this plug to a 2-contact ungrounded receptacle. The adapter has a rigid lug extending from it that **MUST** be connected to a permanent earth ground, such as a properly grounded receptacle box. **THIS ADAPTER IS PROHIBITED IN CANADA.**

Fig. 1-1

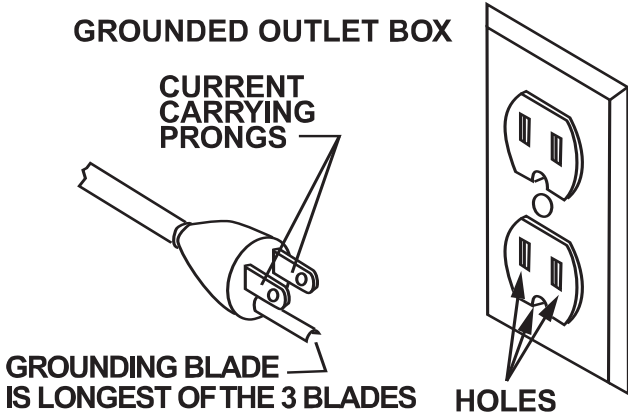

EXTENSION CORDS

⚠ WARNING

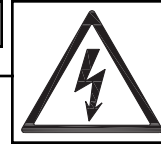

To reduce the risk of fire or electrical shock, use the proper gauge of extension cord. When using an extension cord, be sure to use one heavy enough to carry the current your machine will draw.

The smaller the gauge-number, the larger the diameter of the extension cord is. If in doubt of the proper size of an extension cord, use a shorter and thicker cord. An undersized cord will cause a drop in line voltage resulting in a loss of power and overheating.

Fig. 1-2

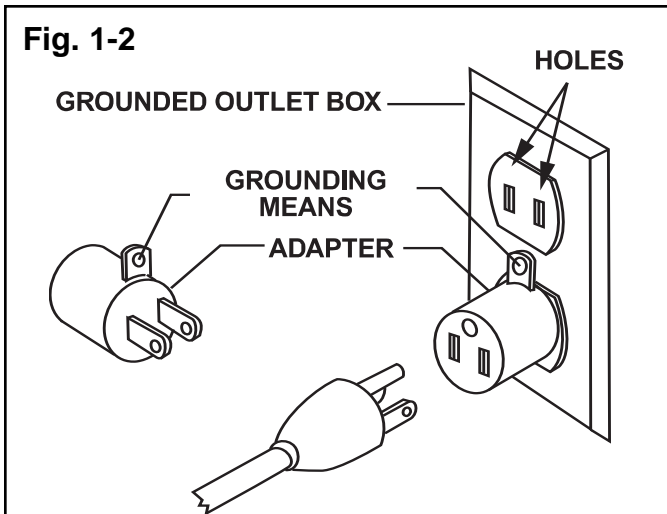

⚠ CAUTION

USE ONLY a 3-wire extension cord that has a 3-prong grounding plug and a 3-pole receptacle that accepts the machine's plug.

If you are using an extension cord outdoors, be sure it is marked with the suffix "W-A" ("W" in Canada) to indicate that it is acceptable for outdoor use.

Make certain the extension cord is properly sized, and in good electrical condition. Always replace a worn or damaged extension cord immediately or have it repaired by a qualified person before using it.

Protect your extension cords from sharp objects, excessive heat, and damp or wet areas.

MINIMUM RECOMMENDED GAUGE FOR EXTENSION CORDS (AWG)

120 VOLT OPERATION ONLY			
	25' LONG	50' LONG	100' LONG
0 to 6 Amps	18 AWG	16 AWG	16 AWG
6 to 10 Amps	18 AWG	16 AWG	16 AWG
10 to 12 Amps	16 AWG	16 AWG	14 AWG

UNPACKING & INVENTORY

This Air Cleaner will require a minimal amount of assembly.

Remove all of the parts from the shipping box and lay them on a clean work surface. Compare the items to figure 1-2, verify that all items are accounted for before discarding the shipping box.

⚠ WARNING

If any parts are missing, do not attempt to plug in the

power cord and turn "ON" the Air Cleaner. The Air Cleaner should only be turned "ON" after all the parts have been obtained and installed correctly. For missing parts, contact Steel City at 1-877-SC4-TOOL.

CAUTION: Make certain shipping blocks have been removed from between cabinet and blower assembly, before unit is turned on. You will have to remove the filters to access shipping blocks.

The following items are to be provided in the shipping box:

Fig. 1-1

A. Air Cleaner

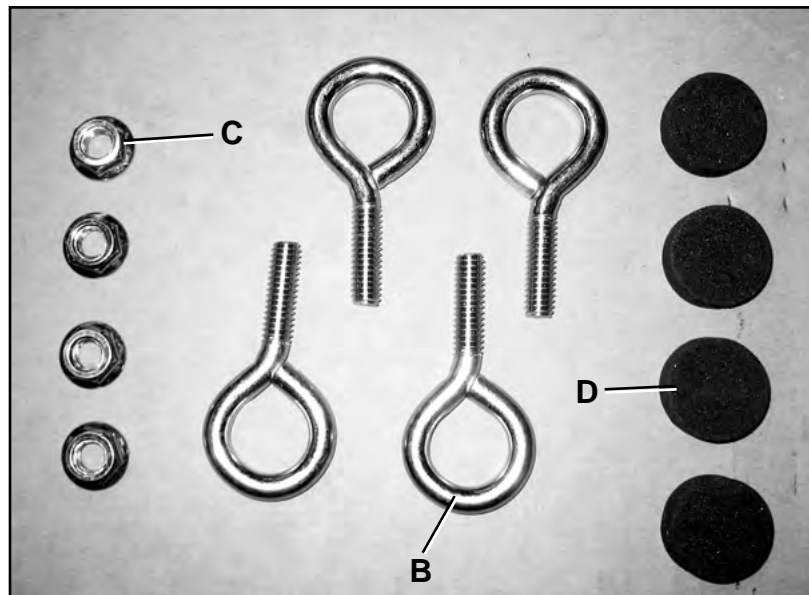

Fig. 1-2

B. Eye-bolt 5/16-18 x 1-1/2" (4)

C. Flange nut 5/16-18 (4)

D. Rubber Pad (4)



ASSEMBLY

⚠ WARNING

1. **DO NOT** assemble the Air Cleaner until you are sure the tool **IS NOT** plugged in.
2. **DO NOT** assemble the Air Cleaner until you are sure the power switch is in the “OFF” position.
3. For your own safety, **DO NOT** connect the machine to the power source until the machine is completely assembled and you read and understand the entire Owner’s Manual.

The Air Cleaner can be used as a portable or stationary unit. As a portable unit it can be moved and placed near the work to be done. As a stationary unit it can be hung overhead in the shop. Determine which type of use is best fitted for your applications and proceed to that section in the assembly instructions.

PORTABLE UNIT ASSEMBLY

MAKE CERTAIN THE AIR CLEANER IS DISCONNECTED FROM THE POWER SOURCE.

1. Place the Air Cleaner on its side. Locate the self-adhesive rubber pads supplied with the unit. Carefully place one rubber pad on each bottom corner of the Air Cleaner. The rubber pads will help eliminate vibration and noise.

CAUTION: For operator safety, we suggest that the unit be clamped down when used on a workbench or positioned on sawhorses.

2. There are two lifting handles located on each side of the air cleaner. These handles should be used to carry the Air Cleaner from place to place. To avoid damage to the air filters, carry the air cleaner with the filters positioned away from your body.
CAUTION: This Air Cleaner weighs approximately 55 pounds.

STATIONARY UNIT ASSEMBLY

⚠ WARNING

THIS TOOL WEIGHS APPROXIMATELY 55 POUNDS. MAKE CERTAIN THE UNIT IS SECURELY SUPPORTED WHEN MOUNTING TO A CEILING OR OVER-HEAD SUPPORT.

1. Remove four screws, one of which is shown at (A) from top of Air Cleaner (B). See figure 2-1.
2. Thread a flange nut 5/16-18 approximately half-way onto the eye-bolt 5/16-18 x 1-1/2”).
3. Thread the eye-bolt with the flange nut assembled into the hole where screw was removed in STEP 1.
NOTE: Thread each eye-bolt eight complete turns into threaded hole.

Fig. 2-1

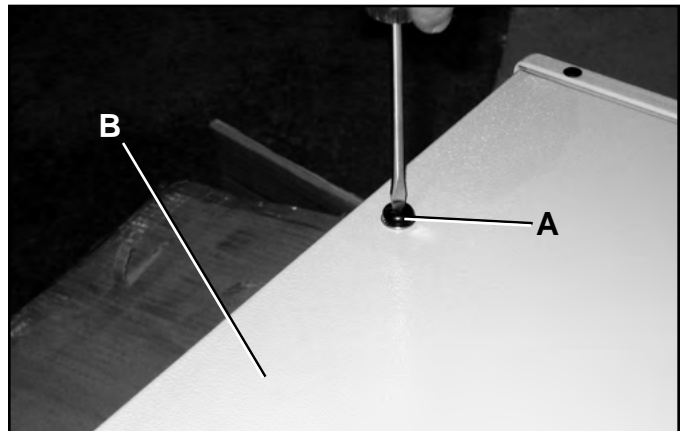

4. Figure 2-2 shows one of the four eye-bolts (E) assembled to the top of the Air Cleaner. **NOTE:** To adjust the height of the Air Cleaner, loosen flange nuts (F) and rotate eye-bolts as necessary. **IMPORTANT:** For safety reasons, eye-bolts must be threaded at least eight complete turns into tapped hole in top of Air Cleaner. Make certain the flange nuts are tightened down against the surface of the Air Cleaner after height adjustments are made.

Fig. 2-2

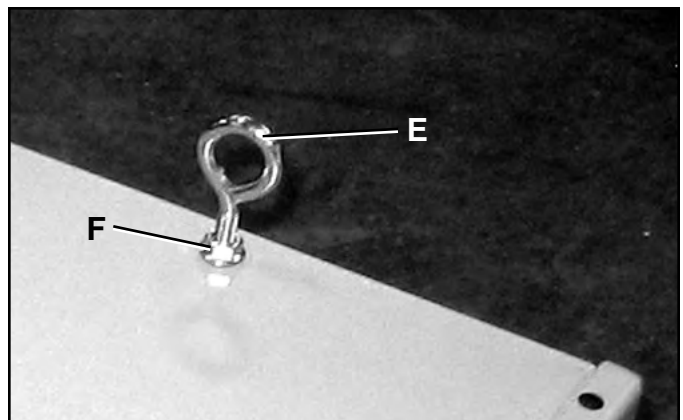

⚠ WARNING

NEVER SECURE MOUNTING HARDWARE TO DRYWALL, DROP CEILING TILE/FRAME OR NON-STRUCTURAL MEMBERS.

⚠ WARNING

KEEP A MINIMUM OF SEVEN FEET BETWEEN BOTTOM OF AIR CLEANER AND THE FLOOR.

DO NOT use rope, cable or power cord to suspend the unit from the ceiling. We recommend that a chain should be used and rated for a minimum of a 150 pound working load to firmly support the Air Cleaner. **IMPORTANT:** When determining a location to mount the unit, the Air Cleaner will operate more efficiently when the air flow is unrestricted. Do not locate the unit in a corner or near any heating or cooling vents.

OPERATIONS

CAUTION: Make certain shipping blocks have been removed from between cabinet and blower assembly, before unit is turned on.

FUNCTION

This Air Cleaner is furnished with two filters: an outer pre-filter which filters particles that are five microns and larger, and a secondary disposable three-pocket inner filter that captures 91% of the dust particles that are one micron and larger (one micron = one millionth of a meter). The Air Cleaner will filter the air in a room measuring 20' x 20' x 8' sixteen times an hour. If desired, multiple units can be used to filter larger areas.

CONNECTING TOOL TO POWER SOURCE

A separate electrical circuit should be used for your tools. This circuit should not be less than #14 A.W.G. wire and should be protected with a 15-amp time lag fuse. Have a qualified electrician repair or replace damaged or worn cord immediately. Before connecting the motor to the power line, make certain the switch is in the "OFF" position and be sure that the electric current is of the same characteristics as stamped on the motor nameplate. All line connections should make good contact. Running on low voltage will damage the motor.

ON/OFF SWITCH

The Air Cleaner is supplied with an in-line rocker switch (A) located on the power cord. To START or STOP the unit, press downward on the rocker switch.

WARNING

DO NOT operate this unit without the filters in place.

NOTE: The Air Cleaner may produce a slight odor for the first couple hours of operation due to the protective coating which is applied to internal components. This odor will dissipate and should be disregarded.

WARNING

DO NOT USE THIS UNIT TO FILTER METAL DUST. Combining wood and metal dust can create an explosion or fire hazard. This Air Cleaner is intended for use where only dry airborne dust is present. Its use should be limited to non-explosive, non-metallic atmospheres.

WARNING

NEVER SECURE MOUNTING HARDWARE TO DRYWALL, DROP CEILING TILE/FRAME OR NON-STRUCTURAL MEMBERS.

WARNING

KEEP A MINIMUM OF SEVEN FEET BETWEEN BOTTOM OF AIR CLEANER AND THE FLOOR.

MAINTENANCE

CHANGING AND CLEANING FILTERS

⚠ WARNING

Turn the power switch "OFF" and unplug the power cord from its power source prior to any maintenance.

Fig. 1-1

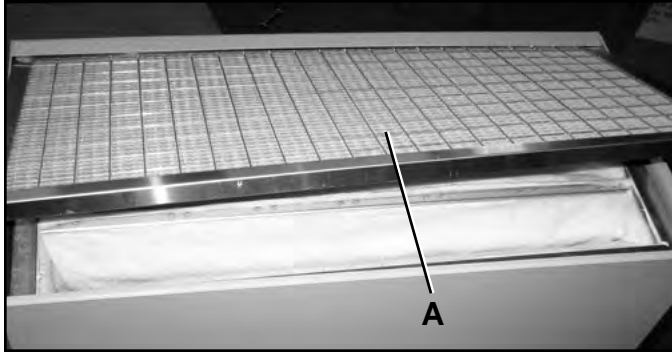

1. Disconnect machine from power source.
2. Lift up and pull out on the bottom of the electrostatic filter (A). See figure 1-1.

Fig. 1-2

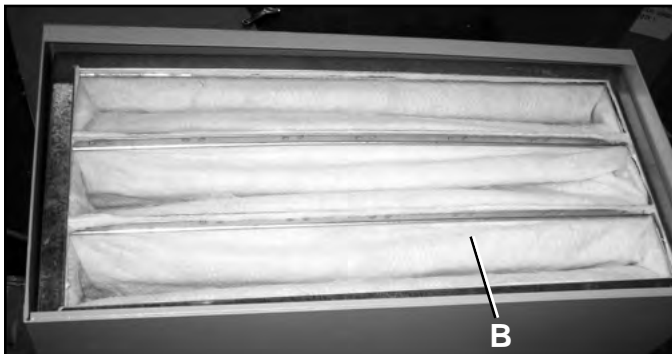

3. Remove the three-pocket inner filter (B) in the same manner as the electrostatic filter. See figure 1-2.
4. Install both filters in the reverse order in which they were removed. **NOTE:** Make certain the AIRFLOW arrow on each filter is pointing inward toward the rear of the Air Cleaner.

5. Both the electrostatic filter and the three-pocket inner filter should be replaced once a year. The electrostatic filter should be cleaned once a month or more often depending on use. When there is a heavy build up of dust on the electrostatic filter, it should be cleaned. The three-pocket inner filter cannot be cleaned. If either filter is torn, bent or damaged in any way, it should be replaced immediately.

The electrostatic filter can be cleaned in one of three methods. Method one is using a shop-vac to remove the dust. Method two is using compressed air to blow the dust out of the filter. Method three is to wash with soap and water.

⚠ WARNING

Compressed air can be dangerous. For operator safety, DO NOT exceed an air pressure of 30 PSI or point air nozzle toward anyone or aim nozzle at your own body. Always wear safety glasses and dust mask when performing this procedure.

LUBRICATION

The Air Cleaner has sealed lubricated bearings in the motor housing that do not require any additional lubrication from the operator.

CAUTION: DO NOT USE FLAMMABLE MATERIALS to clean Air Cleaner.

⚠ WARNING

Repairs to the Air Cleaner should be performed by trained personnel only. Contact your nearest Steel City Authorized Service Center for authorized service. Unauthorized repairs or replacement with non-factory parts could cause serious injury to the operator and damage to the Air Cleaner.

TROUBLESHOOTING GUIDE

TO PREVENT INJURY TO YOURSELF or damage to the Air Cleaner, turn the switch to the “OFF” position and unplug the power cord from the electrical receptacle before making any adjustments.

PROBLEM	LIKELY CAUSE(S)	SOLUTION
Motor does not start.	<ol style="list-style-type: none"> 1. Switch not pressed in far enough or switch in the “OFF” position. 2. Defective switch. 3. Low line voltage. 4. Defective motor. 	<ol style="list-style-type: none"> 1. Depress switch in or make sure switch is in the “ON” position. 2. Have switch replaced. 3. Correct low line voltage condition. 4. Have motor replaced/repaired. <p>NOTE: 2, 3, and 4 must be done by a qualified service technician.</p>
Motor stalls (resulting in blown fuses or tripped circuit breakers)	<ol style="list-style-type: none"> 1. Circuit overload. 2. Low line voltage. 3. Incorrect fuses on circuit breakers. 4. Short circuit in motor; loose connections or worn insulation on lead wires. 	<ol style="list-style-type: none"> 1. Reduce circuit load. 2. Correct low line voltage condition. 3. Have correct fuses on circuit breakers installed. 4. Inspect terminals in motor for damaged insulation and shorted wires and have them replaced.
Motor starts slowly or fails to come to full speed	<ol style="list-style-type: none"> 1. Defective motor windings. 	<ol style="list-style-type: none"> 1. Have motor replaced/repaired.
Motor running too hot	<ol style="list-style-type: none"> 1. Restricted air circulation due to dust accumulation. 	<ol style="list-style-type: none"> 1A. Clean dust and restore normal air circulation. 1B. Clean filters.
Frequent blowing of fuse or circuit breakers	<ol style="list-style-type: none"> 1. Fuses or circuit breakers do not have sufficient capacity. 2. Circuit overloaded. 	<ol style="list-style-type: none"> 1. Have correct fuses or circuit breakers installed. 2. Reduce circuit load (turn off other appliances).

◆ NOTES ◆

PARTS

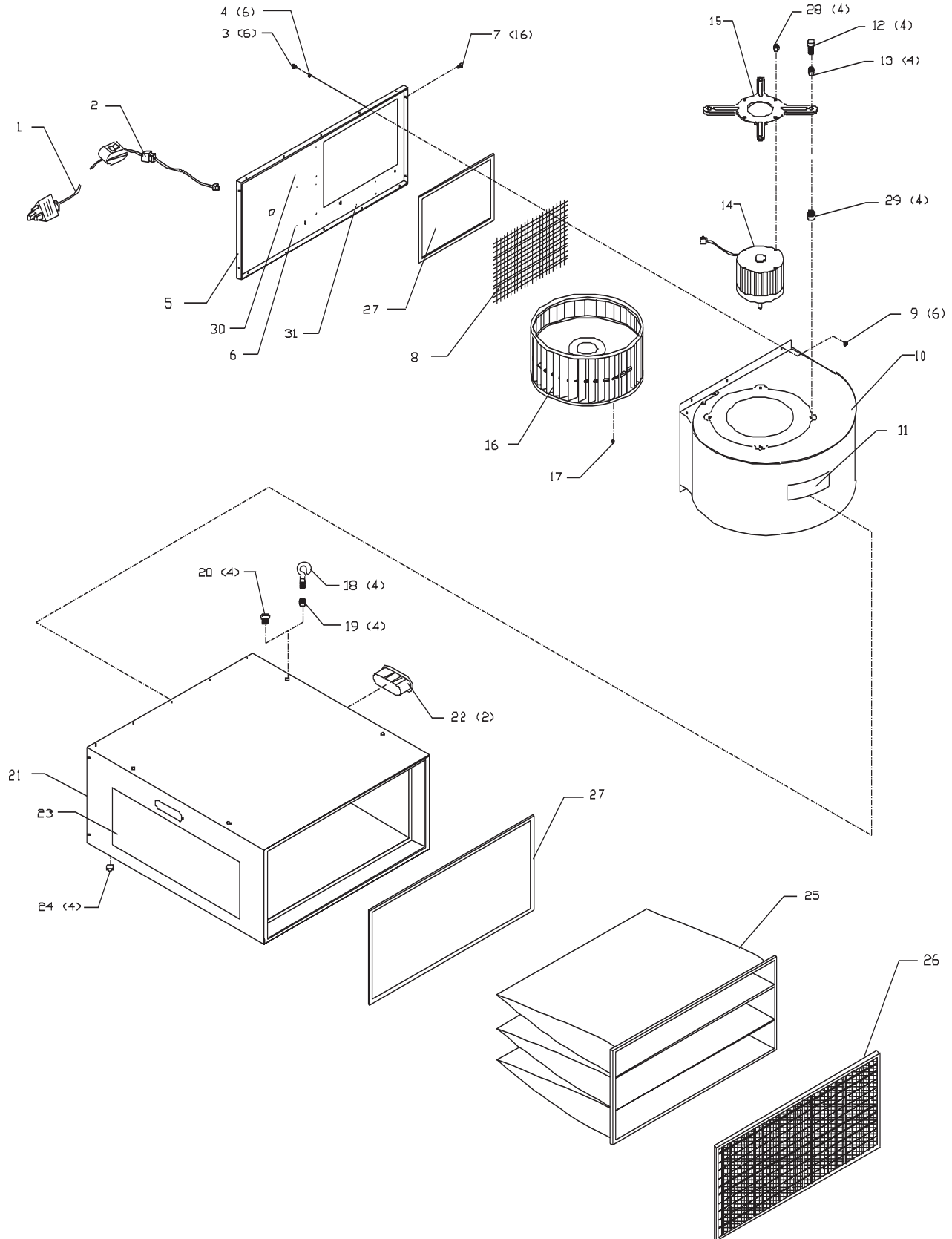

PARTS LIST

KEY NO.	PART NO.	DESCRIPTION	QTY.	KEY NO.	PART NO.	DESCRIPTION	QTY.
1	OR91322	CORD/SWITCH ASSEMBLY	1	24	OR91341	RUBBER PAD	4
2	OR91323	BUSHING	1	25	OR91342	THREE-POCKET INNER FILTER	1
3	OR91324	HEX HEAD SCREW 1/4-20 x 5/8"	6	26	OR70282	ELECTROSTATIC FILTER	1
4	OR90070	LOCK WASHER 1/4"	6	27	OR91345	SEAL	1
5	OR70252	HOUSING END CAP	1	28	OR91346	FLANGE NUT M5	4
6	OR70255	I.D. LABEL	1	29	OR91347	SPACER	4
7	OR90716	PAN HEAD SCREW M4.2 x 12MM	16	30	OR71168	SAFETY LABEL	1
8	OR91327	OUTLET GUARD	1	31	OR72104	SPEC LABEL	1
9	OR91328	FLANGE NUT 1/4-20	6	N/A	OR70251	USER MANUAL, 65100 (NOT SHOWN)	1
10	OR91329	BLOWER ASSEMBLY	1		OR70686	USER MANUAL, 65100 FRENCH (NOT SHOWN)	1
11	OR90601	WARNING LABEL	1		OR70687	USER MANUAL, 65100 SPANISH (NOT SHOWN)	1
12	OR91330	HEX HEAD SCREW 1/4-20 x 1"	4		OR70254	HARDWARE PACK for #65100, INCLUDES	
13	OR90070	FLAT WASHER 1/4"	4		OR91335	EYEBOLT 5/16-18 X 1-1/2"	4
14	OR70407	MOTOR ASSEMBLY, 1/8 HP, AIR CLEANER	1		OR91336	FLANGE NUT 5/16-18	4
14A	OR70356	MOTOR SPEC LABEL (NOT SHOWN)	1		OR91341	RUBBER PAD	4
15	OR91332	MOTOR BASE	1				
16	OR91333	FAN ASSEMBLY	1				
17	OR90310	HEX HEAD SCREW M8-1.25 x 16mm	1				
18	OR91335	EYEBOLT 5/16-18 X 1-1/2"	4				
19	OR91336	FLANGE NUT 5/16-18	4				
20	OR94295	ROUND HEAD SCREW 5/16-18 x 3/4"	4				
21	OR70253	CABINET ASSEMBLY	1				
22	OR91339	HANDLE	2				
23	OR70003	STEEL CITY LABEL, 300mm	2				

◆ NOTES ◆



STEEL CITY TOOL WORKS

www.steelcitytoolworks.com

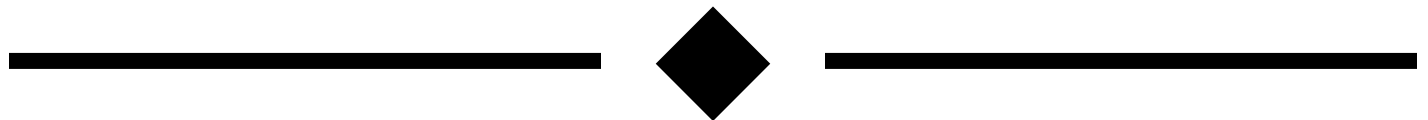

5 Year Warranty

